



**NONRESIDENT  
TRAINING  
COURSE**



May 1993

---

# **Navy Customer Service Manual**

**NAVEDTRA 14056**

**Although the words “he,” “him,” and “his” are used sparingly in this course to enhance communication, they are not intended to be gender driven or to affront or discriminate against anyone.**

## PREFACE

By enrolling in this self-study course, you have demonstrated a desire to improve yourself and the Navy. Remember, however, this selfstudy course is only one part of the total Navy training program. Practical experience, schools, selected reading, and your desire to succeed are also necessary to successfully round out a fully meaningful training program.

**THE COURSE:** This self-study course is organized into subject matter areas, each containing learning objectives to help you determine what you should learn along with text and illustrations to help you understand the information. The subject matter reflects day-to-day requirements and experiences of personnel in the rating or skill area. It also reflects guidance provided by Enlisted Community Managers (ECMs) and other senior personnel, technical references, instructions, etc., and either the occupational or naval standards, which are listed in the *Manual of Navy Enlisted Manpower Personnel Classifications and Occupational Standards*, NAVPERS 18068.

**THE QUESTIONS:** The questions that appear in this course are designed to help you understand the material in the text.

**VALUE:** In completing this course, you will improve your military and professional knowledge. Importantly, it can also help you study for the Navy-wide advancement in rate examination. If you are studying and discover a reference in the text to another publication for further information, look it up.

*1993 Edition Prepared by  
AMHC(AW) Edward L. Prater*

Published by  
NAVAL EDUCATION AND TRAINING  
PROFESSIONAL DEVELOPMENT  
AND TECHNOLOGY CENTER

**NAVSUP Logistics Tracking Number  
0504-LP-026-7240**

## **Sailor's Creed**

“I am a United States Sailor.

I will support and defend the Constitution of the United States of America and I will obey the orders of those appointed over me.

I represent the fighting spirit of the Navy and those who have gone before me to defend freedom and democracy around the world.

I proudly serve my country's Navy combat team with honor, courage and commitment.

I am committed to excellence and the fair treatment of all.”

# CONTENTS

CHAPTER	Page
1. Face-to-Face Contact . . . . .	1-1
2. Navy Customers and their Needs . . . . .	2-1
3. Manning the Contact Point . . . . .	3-1
4. The Team Approach . . . . .	4-1
APPENDIX	
I. References Used to Develop the Traman . . . . .	AI- 1
INDEX . . . . .	INDEX-1

# INSTRUCTIONS FOR TAKING THE COURSE

## ASSIGNMENTS

The text pages that you are to study are listed at the beginning of each assignment. Study these pages carefully before attempting to answer the questions. Pay close attention to tables and illustrations and read the learning objectives. The learning objectives state what you should be able to do after studying the material. Answering the questions correctly helps you accomplish the objectives.

## SELECTING YOUR ANSWERS

Read each question carefully, then select the BEST answer. You may refer freely to the text. The answers must be the result of your own work and decisions. You are prohibited from referring to or copying the answers of others and from giving answers to anyone else taking the course.

## SUBMITTING YOUR ASSIGNMENTS

To have your assignments graded, you must be enrolled in the course with the Nonresident Training Course Administration Branch at the Naval Education and Training Professional Development and Technology Center (NETPDTC). Following enrollment, there are two ways of having your assignments graded: (1) use the Internet to submit your assignments as you complete them, or (2) send all the assignments at one time by mail to NETPDTC.

**Grading on the Internet:** Advantages to Internet grading are:

- you may submit your answers as soon as you complete an assignment, and
- you get your results faster; usually by the next working day (approximately 24 hours).

In addition to receiving grade results for each assignment, you will receive course completion confirmation once you have completed all the

assignments. To submit your assignment answers via the Internet, go to:

**<http://courses.cnet.navy.mil>**

**Grading by Mail:** When you submit answer sheets by mail, send all of your assignments at one time. Do NOT submit individual answer sheets for grading. Mail all of your assignments in an envelope, which you either provide yourself or obtain from your nearest Educational Services Officer (ESO). Submit answer sheets to:

COMMANDING OFFICER  
NETPDTC N331  
6490 SAUFLEY FIELD ROAD  
PENSACOLA FL 32559-5000

**Answer Sheets:** All courses include one “scannable” answer sheet for each assignment. These answer sheets are preprinted with your SSN, name, assignment number, and course number. Explanations for completing the answer sheets are on the answer sheet.

**Do not use answer sheet reproductions:** Use only the original answer sheets that we provide— reproductions will not work with our scanning equipment and cannot be processed.

Follow the instructions for marking your answers on the answer sheet. Be sure that blocks 1, 2, and 3 are filled in correctly. This information is necessary for your course to be properly processed and for you to receive credit for your work.

## COMPLETION TIME

Courses must be completed within 12 months from the date of enrollment. This includes time required to resubmit failed assignments.

## **PASS/FAIL ASSIGNMENT PROCEDURES**

If your overall course score is 3.2 or higher, you will pass the course and will not be required to resubmit assignments. Once your assignments have been graded you will receive course completion confirmation.

If you receive less than a 3.2 on any assignment and your overall course score is below 3.2, you will be given the opportunity to resubmit failed assignments. **You may resubmit failed assignments only once.** Internet students will receive notification when they have failed an assignment--they may then resubmit failed assignments on the web site. Internet students may view and print results for failed assignments from the web site. Students who submit by mail will receive a failing result letter and a new answer sheet for resubmission of each failed assignment.

## **COMPLETION CONFIRMATION**

After successfully completing this course, you will receive a letter of completion.

## **ERRATA**

Errata are used to correct minor errors or delete obsolete information in a course. Errata may also be used to provide instructions to the student. If a course has an errata, it will be included as the first page(s) after the front cover. Errata for all courses can be accessed and viewed/downloaded at:

<http://www.advancement.cnet.navy.mil>

## **STUDENT FEEDBACK QUESTIONS**

We value your suggestions, questions, and criticisms on our courses. If you would like to communicate with us regarding this course, we encourage you, if possible, to use e-mail. If you write or fax, please use a copy of the Student Comment form that follows this page.

## **For subject matter questions:**

E-mail: n313.products@cnet.navy.mil  
Phone: Comm: (850) 452-1001, Ext. 2167  
DSN: 922-1001, Ext. 2167  
FAX: (850) 452-1370  
(Do not fax answer sheets.)  
Address: COMMANDING OFFICER  
NETPDTC (CODE 313)  
6490 SAUFLEY FIELD ROAD  
PENSACOLA FL 32509-5237

## **For enrollment, shipping, grading, or completion letter questions**

E-mail: fleetservices@cnet.navy.mil  
Phone: Toll Free: 877-264-8583  
Comm: (850) 452-1511/1181/1859  
DSN: 922-1511/1181/1859  
FAX: (850) 452-1370  
(Do not fax answer sheets.)  
Address: COMMANDING OFFICER  
NETPDTC (CODE N331)  
6490 SAUFLEY FIELD ROAD  
PENSACOLA FL 32559-5000

## **NAVAL RESERVE RETIREMENT CREDIT**

If you are a member of the Naval Reserve, you will receive retirement points if you are authorized to receive them under current directives governing retirement of Naval Reserve personnel. For Naval Reserve retirement, this course is evaluated at 2 points. (Refer to *Administrative Procedures for Naval Reservists on Inactive Duty*, BUPERSINST 1001.39, for more information about retirement points.)

## **COURSE OBJECTIVES**

The purpose of this course is to make you aware of the importance of the service ratings and the positions that military personnel hold at contact points. In completing this course, you should become aware of the importance of good service and proper attitude in the everyday performance of your duties as a contact point representative. You will demonstrate a knowledge of the subject matter by correctly answering questions pertaining to: face-to-face contact with the

shipmates that occur during the routine performance of their jobs; the nature of Navy customers and their needs, manning the contact

points, and the team spirit and team performance.



## Student Comments

**Course Title:** Navy Customer Service Manual

**NAVEDTRA:** 14056 **Date:** \_\_\_\_\_

**We need some information about you:**

Rate/Rank and Name: \_\_\_\_\_ SSN: \_\_\_\_\_ Command/Unit \_\_\_\_\_

Street Address: \_\_\_\_\_ City: \_\_\_\_\_ State/FPO: \_\_\_\_\_ Zip \_\_\_\_\_

**Your comments, suggestions, etc.:**

<p><b>Privacy Act Statement:</b> Under authority of Title 5, USC 301, information regarding your military status is requested in processing your comments and in preparing a reply. This information will not be divulged without written authorization to anyone other than those within DOD for official use in determining performance.</p>
--

NETPDTC 1550/41 (Rev 4-00)



# CHAPTER 1

## FACE-TO-FACE CONTACT

### LEARNING OBJECTIVES

*Upon completion of this chapter, you should be able to do the following:*

- *Discuss the value of face-to-face contact in customer service.*
  - *Define the terms “customer” “contact point,” “skills,” and “attitude” as they relate to personal interaction.*
  - *Determine the correct approach in using the Navy Customer Service Manual.*
- 

Have you ever waited in line only to be told, when you finally reached the window, “Come back tomorrow; the person responsible for that isn’t here”? When trying to get a question answered, have you ever had the feeling that the person you were talking to resented being bothered? Have you ever had to resubmit a request because the original was lost?

Are you convinced that there are good reasons (not excuses) for any of the above situations? The Chief of Naval Operations is not, and a great many others in the Navy are not.

Only a wishful dreamer would expect all Navy members to be dedicated 100 percent to their work, but only a confirmed pessimist would declare that the Navy is as good as it could be.

There must be a point between these two extremes at which those who provide services can handle problems and requests correctly, promptly, and courteously. In other words, there must be a point at which contact point representatives can efficiently satisfy the needs of customers.

Everyone in the Navy is directly or indirectly responsible for providing efficient customer service. However, of the many ratings in the Navy, only a few provide direct services to other personnel. These include the AK, DK, DT, HM, LI, LN, MS, NC, PC, PN, RP, SH, SK, and YN ratings. Although the principles given in this manual are intended mainly for personnel in these ratings, those in other ratings can certainly benefit. They

can apply these principles daily on and off the job during face-to-face contact with other personnel.

### PROVIDING SERVICE

Think back to some recent contact you have had with one or more of the personal service ratings. How would you rate the service you received? If you are a member of one of the personal service ratings or perform service-type duties, how do you think your service would be rated by those you serve?

Now, let’s go one step further. What effect did this good or bad service have on the person served? How do you respond to courteous treatment or efficient action? Or viewing it from the opposite side, how do you respond to a don’t care attitude or bad service?

Although you can’t always provide customers with everything they may request, you can always give them good service. People may request things or services for which they aren’t entitled or to which you haven’t the authority to grant. In such cases *service* refers to the quality of your service rather than whether or not you have complied with all of a person’s wishes. The runaround, the fast shuffle, or a don’t-bother-me response given to an individual needing service indicates one of the following attitudes:

The customer isn’t important.

The customer’s request or problem isn’t important.

The customer doesn’t know what he is talking about.

The customer doesn't know what he is talking about. I have more important things to do.

Many of the people entering the Navy do not have a clear idea of what *Navy life* is really like. Their perceptions have been influenced by friends, parents, movies, books, and TV; a sense of responsibility to their country (patriotism); the glamour of the uniform and tradition; the opportunity to travel; and the desire to make it on their own. They have all been screened and generally are the type of people the Navy wants-intelligent, healthy, and motivated. In general, they have a lot to learn and a need for a lot of maturing. Although their development may require a lot of hard work, they possess a high potential for becoming valuable Navy members. They will become members who value their role and status in the Navy and value the contributions they can make to the Navy and their country.

If these people are generally intelligent and motivated, then why the attitude change during their first term of enlistment? What happens during the first 4 years to make them count the days until they will get out? Part of the reason is the demands placed on the Navy member. A special person is needed to handle those demands, and the person who is unable to handle them could never be happy making a career of the Navy. Even so, some members have left the Navy who might have stayed in had they not faced frustrations and disappointments during their first enlistment. Everyone has inconveniences and disappointments to contend with, and everyone expects them. But what people do not expect and should not have to contend with is a lack of service—service that would enable them to cope with everyday demands. Better human relations will not eliminate their inconveniences or disappointments, but can prevent the frustrations resulting from inadequate service.

The effect of bad service is much more lasting than the momentary anger or disgust felt by the recipients of that service. Frustration and resentment resulting from bad service often develop into a negative attitude toward the Navy. On the other hand, good service builds a good attitude in customers. Good service is an indication of capable, knowledgeable, and interested workers and a naval service that cares about its members.

Naval personnel have special needs resulting from away of life that is quite different from that of civilians.

A civilian may:

seek employment in any occupation;

seek employment at any location;

negotiate the amount of pay to be received;

refuse a job or quit a job if that seems to be the best career option;

choose the amount, the type, and the location of training or education best suited to his or her resources and capabilities;

work a 40-hour week;

lead a normal homelife;

accept a transfer only when it is convenient and financially beneficial

The Navy member must:

serve, not always in the rating of choice;

serve at any location to which ordered;

manage on the amount of pay prescribed by law;

perform assigned duties for the duration of the enlistment;

be willing to accept prescribed training to meet the needs of the Navy;

routinely work days, nights, weekends, and holidays;

often experience long periods of separation from family;

often relocates the family at inconvenient times—causing a financial loss.

For the Navy to fulfill its mission, members often must sacrifice their freedom of choice to meet the needs of the Navy. They must depend upon the Navy to provide them with training and achievement opportunities as well as challenging and rewarding work experiences. They must also depend upon the Navy to meet their physical and psychological needs.

You will probably administer one or more of the medical, financial, educational, and recreational benefits and services the Navy provides its members and their dependents. These benefits and services range from paying costs imposed on members because of transfers to providing opportunities for personal improvement that they otherwise might not have. You must value the importance of these services to Navy members and their families. As a member of a service

rating, you are the all-important link between the member and these benefits and services.

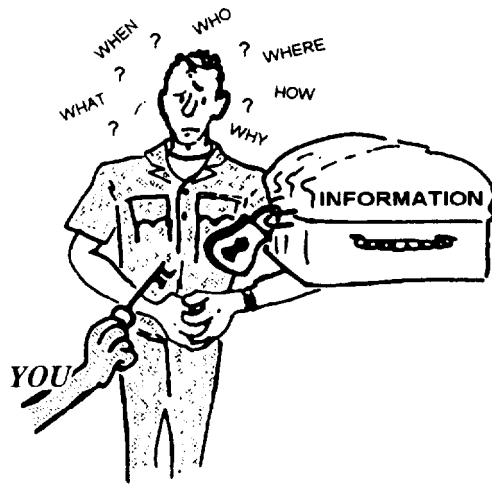

For a civilian, several places may offer the same or a similar service. There is usually more than one grocery store, more than one barbershop, more than one service station, more than one laundry, and so forth. But, the situation is very different for the individual in the Navy. There is only one personnel office, one disbursing office, one ship's store, one division office, and so on.

While going through the mess line, you probably have heard someone criticize the meal only to be advised, "If you don't like our food, try the restaurant across the street." This advice might have been acceptable if a restaurant had been located across the street—but one wasn't. The person had only one choice: eat what was offered. Of course, not all criticism is valid; sometimes it is merely griping. But this example illustrates the point that most activities normally have only one place where members can go for a specific service. They do NOT have a choice.

Since the members do not have a choice, neither do you! Your service is not to be considered a favor. Rather, you are meeting your responsibility.

### **EFFECT OF GOOD/BAD SERVICE**

The Navy is definitely affected, either directly or indirectly, by the service you provide to its members. Earlier, we said that bad service causes customers to develop an attitude of resentment. However, seldom do they restrict that attitude toward the person who gave the poor service. Instead, they soon generalize that attitude toward the whole Navy.

Machinery and equipment can be purchased when needed—conscientious, dedicated people cannot. Thus, it is apparent that capable *people are the Navy's most valuable asset*. As strange as it may seem, the Navy is constantly losing these assets—its capable petty officers. The choice to reenlist or leave the Navy is a personal matter, and the decision usually represents a carefully thought-out career plan. But, in some cases, a member's decision to leave the Navy has nothing to do with careful planning. Instead, the member's decision has resulted from frustration and dissatisfaction with the services the Navy has provided. In these cases, the Navy has lost not only the person but, the investment of expensive training.

You may ask, What can I do about it? My job isn't important! I only perform a personal service or provide for a personal need. **THERE ARE NO UNIMPORTANT JOBS!**

Few changes are made just for the sake of change. First, a need is recognized, and then new procedures are developed to meet that need. Recognizing a need is also the first step in making improvements in the area of a service. We must understand that even the best of services have room for improvement. With this in mind, everyone involved in providing service must recognize the constant need for improvement.

### **RECOGNITION OF NEEDS**

Before discussing needs, let's first consider the people who have them. Everyone in the Navy has needs. The failure of these needs to be met quite often develops into problems that far exceed the original needs themselves. However, the level of service required to meet their needs and solve their problems varies. For example, experienced senior petty officers require less advice and fewer explanations and interpretations than the less experienced junior petty officers. Since the experienced members know more about the services to which they are entitled, they are less likely to accept poor service. Although all members depend on others for services, new enlistees, their dependents, and new civilian employees probably have the greatest need.

The need for improved services is apparent based on the comments Navy members make. Let's analyze members' desires and feelings as a first step in determining how improvements can be made:

- They want to be regarded as individuals.



- They feel that, as a person, they are worthy of more attention than that given in a mechanical and routine fashion.
- They want to be treated equally, fairly, and with concern for their welfare.
- They want to be able to rely on more experienced members for advice and proper action in their behalf.

Improved human relations is essential if customer service is to improve.

This manual shows how you can respond more helpfully to your shipmates by developing a greater sensitivity to their needs. This manual doesn't provide you with all the answers for interacting effectively with people. However, it does tell you how to deal with the various human relations you will face daily.

More than mechanical skills are involved when you are working with people. Your attitude doesn't affect a machine with which you are working, but it does affect people—they care how they are treated! Although your attitude might affect the quality of your work, it will have the greatest impact on the personnel receiving you service. Your manner, your speech, and the way you perform your job will influence the member's attitude toward you, toward your office, and toward the Navy.

### **CUSTOMER SERVICE TERMINOLOGY**

Before going further, we will define four terms that are frequently used throughout this manual: customer,

contact point, skills, and attitude. By no means are these terms new, but for the sake of this instruction, we will define them.

### **CUSTOMER**

First, let's consider the familiar term *customer*. In your role within the Navy, you are frequently a customer, although you might not think of yourself as one. If you are a member of the service ratings, you may also provide services to customers within the Navy? For the purposes of this manual, we will use the term *customer* to refer to anyone for whom a service is provided.

Some services offered to customers within the Navy include, but are not limited to, the following:

- Food service
- Health service
- Resale activities
- Information service
- Advice and counseling

Although you may receive some of these services without purchasing them, you are still a customer.

The following are some specific instances in which a Navy member is a customer:

- Going through the dining facility serving line
- Making a claim for travel

- Going to sick call
- Obtaining information on educational opportunities
- Receiving dental assistance
- Being processed for reenlistment
- Mailing a package at the ship's post office
- Checking out a book in the library
- Submitting a leave request



The following are some instances in which dependents are customers:

- Receiving medical care

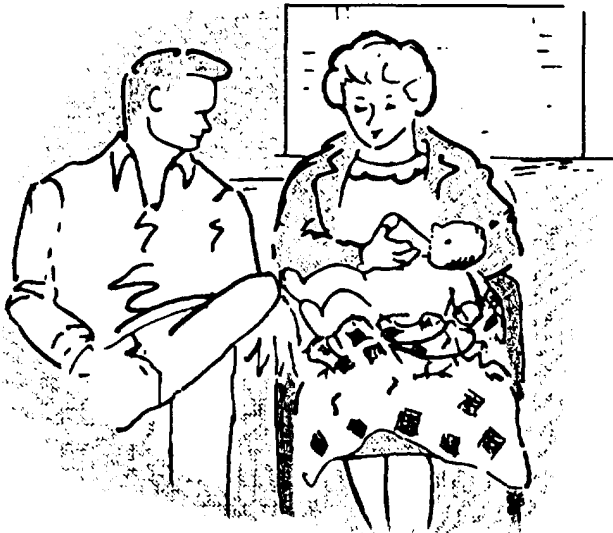

- Arranging for shipment of personal property
- Shopping in the Navy Exchange
- Attending the theater

- Using the swimming pool

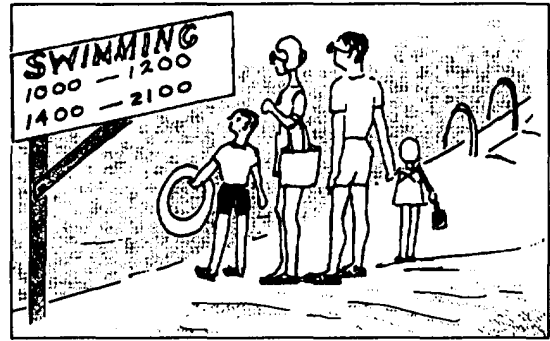

The list could go on and on, but these examples show that everyone may be a customer several times a day. Other terms may be interchanged with the term *customer*. *Client*, for example, refers to anyone for whom a service requiring some degree of confidentiality is provided. *Patient* usually refers to someone for whom a health service is provided. The term *customer* merely refers to a person for whom a general service is provided.

## CONTACT POINT

*Contact point* is, very simply, the physical location to which a customer goes to obtain a service. Some examples of contact points are as follows:

- Sick bay
- Dining facility
- Post office
- Ship's store
- Legal service office
- Ship's office
- Personnel office
- Disbursing office

These points are manned by the persons who provide direct services to customers. Indirect services provided by other ratings pertain more to the operation of the ship or activity and are not necessarily performed at a contact point. The following are examples:

- The MM or FN operating the evaporators to provide fresh water
- The BM or SN who keeps the liberty boat in operational condition

- The YN who types and prints the plan of the day
- The AK or AN who procures parts and supplies for operational commitments

Ships and activities have various contact points. The size of the command, number of personnel assigned, and the scope of service provided are factors that determine how many contact points are needed. These contact points are where you, your dependents, your seniors, and your subordinates go to obtain services, advice, and answers to questions. They are important because the services they provide are important. However, the quality of those services is determined by the persons providing them—YOU ARE ONE OF THOSE PERSONS.



Because “contact point representative” is a rather long title, the word *you* is used in this manual when referring to the person manning the contact point. Therefore, *you* may refer to the reader or to the contact point representative.

## SKILLS

*Skill* is the ability to do something well as the result of talent, training, or practice, or a combination of these. A multitude of skills come into play in your day-to-day activities—military, professional, and athletic skills, just to mention a few.

We are concerned here with face-to-face, or interpersonal, skills. These are the skills that enable you to interact effectively with people. Basically, these skills include the ability to listen to, work with, and speak to an individual as a PERSON and NOT as an inanimate object.

The structure of the Navy tends to foster an impersonal attitude in its members. We never see the people who make most of the decisions that affect our

lives—type of duty, permanent change of station, and entitlement for medical. Our relationship with these people does not involve face-to-face contact. However, that is not the type of relationship that exists aboard ship or at a station. There, you are face to face with the customer; there, the relationship becomes personal.

This personal interaction (action and reaction) requires face-to-face skills if it is to be effective. People who are the most successful in sales are normally the ones who can apply face-to-face skills. They LISTEN to customers so that they can better understand their needs; they SPEAK to the customers so that customers understand fully what they are saying. They make every effort to ensure customer satisfaction.

Your effectiveness at the contact point depends on how well you listen, speak, and respond to the customer’s needs—how well you acquire and use face-to-face skills.

## ATTITUDE

*Attitude* can be described as the tendency to move toward a situation or away from it. It results from either a positive or negative outlook or feeling toward a subject. It involves a like or dislike (based on a habit, a previously formed opinion, or a current snap judgment) for someone or something.

The following illustration, provided by a television spot concerning human behavior, is a good example of a positive-negative outlook:

Look at the glass below. Is it

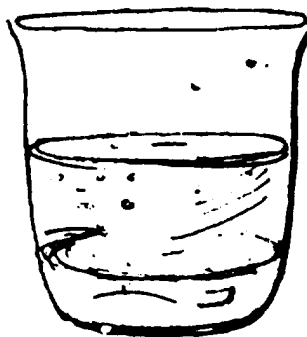

**HALF  
EMPTY  
or  
HALF  
FULL  
?**

Do you see the filled portion or the empty portion of the glass? Do you see “what is” and resolve to make the most of it, or do you see and resent “what is not”?



Attitudes can't be measured or graded, but the effect or results of our attitudes can be. "They are apparent in our actions and performance. You may have said or heard someone else say, "That person has a poor attitude." How was this opinion formed? Was it formed as the result of the way that person acted toward coworkers or customers or the way that person completed his or her work?

Let us look at some specific instances in which attitude plays a big part. Consider an aircraft mechanic in the process of making a preventive maintenance (PM) check on a jet engine. Suppose the mechanic sees a loose wire or a badly worn part not included on the PM card but does nothing about it. On a flight the next day, the engine malfunctions and flight operations are disrupted. Was the mechanic's neglect a dereliction of duty? Probably! However, we are not considering the legal aspects of the act, but the negative attitude that prompted it. Similarly, a negative attitude is demonstrated by the cook who scorches the eggs, the liberty boat coxswain who drives into every wave, or the Hospitalman (HM) who loses your shot record. The mechanic isn't going up in the plane. The cook has already eaten. The coxswain is in the duty section. The HM isn't going to have a sore arm as a result of the shots. These people aren't interested in doing a *good* job; they just want to get through the day.

People are said to have a positive attitude toward a situation or person when the consequences are pleasant or desirable. For example, you may be said to have a positive attitude toward a friend because you enjoy the friend's company.

You are said to exhibit a negative attitude toward an individual or situation when the consequences are painful or otherwise undesirable. For example, you drive carefully because of your concern for the safety of your passengers as well as the other drivers.

Why bother talking about attitudes? After all, people are people, and you can't change human nature. Not true! Human nature constantly changes—as attitudes change.

How do attitudes change? First, YOU must become aware of the desirability and advantage of change. Second, YOU have to change your attitude—no one can do it for you.

SN Doe is assigned to a galley working party by his leading petty officer (LPO). SN Doe is angry that he has been given this detail again. AN Frost is assigned to the same detail by his LPO. Both sailors show up for the

working party. Doe tells Frost that he is tired of working parties and he feels he shouldn't be there. He says he is going to request to see the captain to find out why he is assigned to so many working parties. Frost says, "Hey man, working parties don't last forever; besides the work we do helps everybody. It provides service to the galley so that the crew gets good hot chow, and we do not have to eat sea rations."

## **Pride**

Since our attitude toward others is a reflection of our attitude toward ourselves, we must have a proper appreciation of ourselves.

We should not be too impressed with our accomplishments, nor should we be excessively critical of them. Staying in touch with reality is a excellent approach to developing a healthy attitude. You may not be all that you would like to be; but you are who you are, and you should feel good about that. You are valued as a person, you have accomplished certain things, and you have the ability to climb higher.

Recognizing who you are, what you are, and what you hope to become will enable you to meet each day with an expectation of winning rather than a certainty of defeat.

Without a degree of pride in yourself, your ability, and your job, you are unlikely to put forth your best effort. You are more likely to perform only when told to do so, and then only at a minimal acceptable performance level.

## **Courtesy**

Regulations do not require courtesy beyond that required for formal military protocol. Formal courtesy is that which is demanded by custom and tradition, and failure to observe it can result in unpleasant consequences. But, common courtesy is a totally different subject.

Common courtesy goes beyond what we are required to do. It is a voluntary expression of respect for another's rights or feelings. It is opening a door for someone heavily laden with packages. It is showing military courtesy and respect for a person rather than merely giving the required recognition. It

is treating the customer as a person with a problem that is important.

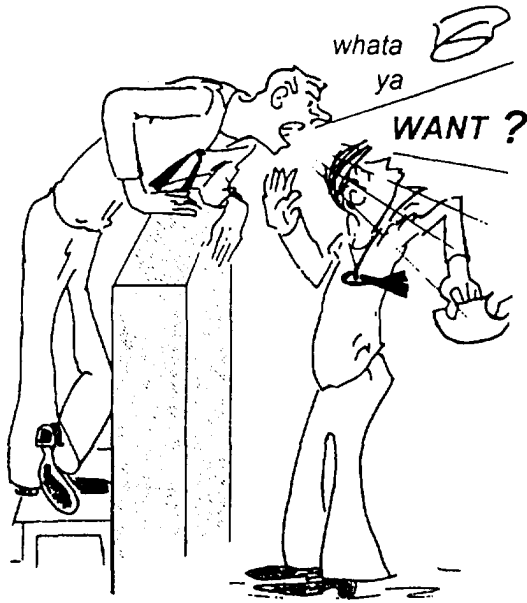

## Cooperation

You can probably “get by” if you do just what is required by the organization chart, a job description, or specific instructions, but cooperation smooths a lot of rough spots. Being cooperative is working WITH the other members of the team for the purpose of improving individual performance and overall efficiency.

Cooperation is necessary when “breaking in” a new member of your organization. Mary has just been assigned to your office, and it’s up to you to help her get started on a job that she has never done before. You could just show her how to perform the mechanics of the job and let her muddle through on her own. But wouldn’t explaining the job and telling her where to find answers to her questions make her job easier and her job performance better? Doing that also has a practical application—it can prevent many mistakes you may have to correct.

An element of cooperation is required when responding to customers’ needs. They will often need information or assistance from another office before you can act on their request. You can send them on a “wild goose chase” to get it; or you can provide them with specific instructions on what to get, where to get it, and how to get it. You might also make a phone call so that they will be expected.

## Behavior

Our behavior (the things we choose to do or not to do) is the result of our attitude (our reasons for doing or not doing those things). Our behavior on the job is affected by our attitude toward our job, our coworkers, the customers, and the Navy. But another set of attitudes (not job related) also influences our performance on the job.

Let us try to provide an example to show how attitudes are developed. Walter T. Door rolls out of his bunk as reveille is sounded and heads for the shower in preparation for another day at sea. But, there is no hot water! With a few caustic comments about the “water king,” he proceeds to shave—in cold water. By now, his mutterings include the entire “A” gang. Splashing aftershave lotion on his scraped and burned” face, he starts back to his locker only to stub his toe on the hatch. Grabbing his throbbing toe, Poor Walter drops his toilet kit. Any other time the contents of the kit would have only spilled, but this morning his new bottle of shaving lotion breaks. Walter’s fuse is getting shorter. As he dresses, he fumes at the missing shirt button and the fact that both socks are inside out. He shoves his feet into his shoes, very much aware of the injured toe, and decides not to tie his shoe laces. Now, he goes to breakfast. The menu lists a favorite, ham and eggs to order. But Walter is late, and the mess is now serving fried bologna and scrambled eggs. Walter finally gets to the office. What do you think his attitude will be when the division petty officer walks up and says, “Walter, we have an UNREP scheduled for 0930 today. According to the working party rotation list, you are next in line. The store-handling team will muster at 0915 on the fantail.”

Everyone has days like that one experienced by Walter. They are just a slice of what we call life experiences, and these occurrences can greatly influence on-the-job performance and attitude. However, you must strive not to let them negatively influence yours. It’s no easy task to overcome them, but overcome them you must if you are to respond to the customer and to your coworkers as you should. Though customers are not responsible for such events, they are often the victims of poor service because of them.

## THIS MANUAL

“How to” books are available for almost any subject—how to build a house, how to build a plane, how to build a boat, how to repair your car, and even a how to diet and live with it. These books are written for

those who have an interest in those things, but lack the “know how” to do them.

In a way, this manual is also a “how to” book but it does have a slightly different approach. To begin with, you already possess the “know how”—everyone really knows how to be courteous and helpful. When we don’t do what we should, either we don’t care or just didn’t stop to think how our actions might affect the other person. The intent of this manual is to impress upon you the importance of caring and the effect of your actions and attitude toward others.

This manual first identifies undesirable personal traits of members that can make the Navy less than it can be. It asks you to evaluate yourself so that you can become aware of areas needing improvement. Then, by showing the advantages of improvement to you and to the Navy, it dares you to accept the challenge of self-improvement.

We in the Navy have a real need to improve our human relations. Human relations often are the deciding factor as to whether a member likes the Navy or dislikes it.

## **EXAMPLES WITHIN**

Chapter 2 is a series of case studies, or examples, of the type of service that is often encountered in the Navy. Some of these examples are limited to specific ratings, others are not. Some portray good service, others poor.

The purpose of these examples is to help you evaluate your own attitudes and abilities. To say that something is “better” really doesn’t say much unless you go a step further by adding “than \_\_\_\_\_.” That is evaluation, and evaluation can be simply described as the weighing of all known factors to determine a best course of action. In team sports, each team is constantly evaluating the strengths and weaknesses of the other so that it can plan its strategy.

Self-evaluation requires that you weigh your own strengths and weaknesses—not an easy task. It’s much easier to evaluate someone else’s strengths and weaknesses because you are less likely to be distracted by excuses and rationalization. The performances described in the examples will help somewhat in this respect since you can examine, and then compare, your performance with those described.

## **REFERENCES TO EXAMPLES WITHIN**

Chapters 3 and 4 examine the needs of Navy members and, by referring to the examples in chapter 2, identify the attitudes and skills necessary to meet those needs,

Chapter 3 gives examples on the basis of the individual—you. What attitudes and what skills do you need? Why? How can you improve them? Why should you even try?

Chapter 4 examines the team—all the people who work at the contact point. It points out your responsibilities to the team and the team’s responsibilities to you. It demonstrates how team members can assist each other in providing improved service.

## **ATTITUDE TOWARD**

We have discussed the importance of a good attitude as it relates to doing a job well. Attitude is also important as you read this manual. As you read, ask yourself, What does this example say to ME? Do I exhibit any of these undesirable traits? If so, what difference would it make if I didn’t? If you take this attitude, you are likely to find some areas in which you can improve simply by being aware of the need for improvement. However, if you read it with a closed mind—that is, with the attitude that everyone is out of step but you—your efforts will have been futile.



## CHAPTER 2

# NAVY CUSTOMERS AND THEIR NEEDS

### LEARNING OBJECTIVES

*Upon completion of this chapter, you should be able to do the following:*

- *Discuss your personal inventory when providing customer service to Navy personnel.*
- *Discuss the personal inventory examples in this chapter.*
- *Discuss the role of the customer and the effectiveness of your performance.*
- *Identify the role of the contact point representative.*

Chapter 1 addressed the need for contact point representatives to improve their face-to-face skills. In this chapter, we will begin breaking down the overall problem involved in face-to-face contact. We will use two methods in doing that:

First, this chapter contains a list of the abilities and traits a contact point representative should have. We will ask you to compare your own abilities and traits with those listed.

Second, this chapter provides examples of incidents that could occur at various contact points. We will ask you to evaluate the performance of the contact point representatives in each example.

### RESPONDING TO NEEDS

Much has been written and said about the “can do” spirit of our country. We often see this spirit when the people of this country respond promptly to some great challenge. Our people claim to have the ability, or the “know how,” to deal with the most challenging obstacle. If that claim is true, then we have no excuse for failing to respond promptly to routine tasks as well. Although routine tasks do not motivate us to respond as we would to some challenging obstacle, our responses to both may be equally important.

A “will do” spirit of determination needs to accompany our “can do” spirit. When a customer with a problem asks, “Can you help me?” your reply should

be, “Yes, I can.” To this reply, you should respond with action and an attitude that say, “and I will.”

### PERSONAL INVENTORY

Make a personal inventory of yourself as a contact point representative by studying the following checklist of the abilities and traits you should have. The intent of the checklist is to help you learn which abilities and traits you have and which ones you need to develop or to improve upon.

Read the items carefully; then decide which item in each column best describes the ability or trait you have. Do you rate good, poor, or somewhere in between? Being objective in rating yourself isn’t easy, but the checklist can help you identify traits and abilities on which you need to concentrate.

Self-Evaluation Checklist

	Are you here?	Or do you need—	
		Some Improvement	Much Improvement
1	Present good personal appearance		Careless about appearance
2	Excellent knowledge of rating		Poor knowledge of rating
3	Good work organization		Poor work organization
4	Office/personnel records in top condition		Office/personnel records sloppy

### Self-Evaluation Checklist—Continued

	Are you here?	Or do you need—	
		Some Improvement	Much Improvement
5	Know the sources of correct information		Always have to ask someone else
6	Good command of English (written and oral)		Poor choice and use of words
7	Accept responsibility		Avoid responsibility
8	Considerate of co-workers		After me, they come first
9	Pleasant, outgoing, friendly		Surly, argumentative, sarcastic
10	Treat each customer as an individual		They're just service numbers
11	Treat all customers with equality/fairness		Take good care of friends
12	Give customers only correct information		Give them an answer and get rid of them
13	Considerate of customers' time		Only considerate of own time
14	Genuine interest in customers' problems		Resent problems; they cause work
15	Go the extra step to ensure customer satisfaction		I do my job

### EVALUATING THE EXAMPLES

The examples provided in the following section of this chapter provide scenarios that could be considered to be realistic for the activity of a contact point. Each scenario relates to a trait or an ability on the self-evaluation checklist. Keep in mind that the scenarios do not show a true overall view of contact point operations or the performance of contact point representatives.

The scenarios name specific ratings and contact points; however, you should direct your evaluation toward the *person* providing the service, NOT toward the rating or the contact point. No attempt was made to develop examples that could cover every possibility; however, they do cover a range of attitudes and skills that make the difference between good service and marginally adequate service.

The purpose of this chapter is to help you identify actions and attitudes associated with good service.

Therefore, none of the examples cover the first item on the checklist, "Presents good personal appearance." Checklist items 2 through 6 relate more to the requirements of your rating than to the face-to-face skills needed at contact points. Therefore, the examples emphasize the traits and abilities contained in items 7 through 15. These items deal with traits that affect the way you respond to customer needs.

In evaluating the performance of the people described in the examples, you are asked to assume two roles: (1) the role of the customer and (2) the role of the contact point representative.

### ROLE OF THE CUSTOMER

The customers at your contact point do not see, and are not particularly interested in, your total work load. They see only your response to their needs at that specific time. Thus, the customers' opinion of your job effectiveness may be as distorted as that described in some of our scenarios, since both deal with only a brief part of a day's work. Some of the scenarios may not provide enough detail to allow you to evaluate the representative fairly. However, you must remember that is also the basis on which your customer evaluates you.

### ROLE OF THE CONTACT POINT REPRESENTATIVE

In the role of the contact representative, you are aware of the total work load and responsibilities of the job. Because you have this broader base of knowledge on which to make an evaluation, you may even justify and excuse some of the representatives' actions. In evaluating the examples, don't excuse actions because of a misplaced sense of loyalty to your fellow workers. Remember, you are responsible to all members of the Navy, not just to those in your rating.

### SCENARIOS

Each of the following scenarios, or cases, is followed by a checklist of items you are to evaluate from the information given. A brief critique following each item points out the evidence on which you can make an evaluation and suggests possible causes and improvements.

You may find some similarities between the attitudes shown in the examples and your own. That will help you to identify traits and abilities you need to develop or improve upon.

## CASE NUMBER 1

MS3 Frost and MSSN Doe come into the Navy at the same time and go through recruit training and A school together. Then they receive orders to the same ship. While they remain together during their time in the Navy and become good friends, their attitudes and ambitions are quite different. MS3 Frost makes his rate the first time up. MSSN Doe takes the test twice and fails both times.

Suppose we interview the two men and see if we can identify some of their differences.

Question: Tell us a little about your job.

MS3 Frost: I like my job. Basically, it involves preparing three meals a day, 7 days a week, either at sea or in port. By using the menu to make breakouts, I have a current knowledge of stores remaining on board. This makes me feel that I have a part in managing inventory. We use the menu to make breakouts of food items and plan for the meals that follow.

MSSN Doe: It's a great job! No responsibilities, easy work, my room and board, and I get paid for it.

Question: MS3 Frost, you said that you like your job. What is it that you like about it?

MS3 Frost: It would be difficult for me to identify one thing that would stand out over another, but the fact that my rating is interesting and that it provides variety means a lot. I enjoy interacting with the crew; and this job provides mean opportunity not only to provide a service, but to talk with each of the crew members. Often this interaction provides me knowledge of what they would like to see more of on the line or items they would prefer to see less of.

Question: MSSN Doe, you said the job is easy. Is that all it has going for it?

MSSN Doe: I guess so. I haven't given it much thought. It's a job. The chief makes out the menu, and tells me what I have to do. I just follow the recipes.

Question: MSSN Doe, you said you have no responsibilities and implied that you don't want to have any. Do you consider responsibility something to be avoided?

MSSN Doe: I do now. The food service officer and the chief are paid more than I am; they should have the responsibility.

Question: Do you agree with this, MS3 Frost?

MS3 Frost: It's true that both the food service officer and the chief are paid more, but I feel they have equal responsibility for their pay. I would like to assume as much responsibility as the chief will allow me to have so that I may learn as many skills as possible. I view these skills as valuable in planning a career either in the military or in the civilian sector. As far as responsibility, I feel that everyone in the food service division has a responsibility to the crew to observe rules of sanitation and to make each meal nutritious and tasty. The food service officer and the chief have the training and experience that qualify them for this, but I have responsibilities also. "There are many ways to do a job—my responsibility is to do it right.

Question: Since the chief prepares the menu, do you really have a choice of what foods you prepare?

MSSN Doe: Who wants to choose? If the menu calls for meat loaf, they get meat loaf, if it calls for mashed potatoes, they get mashed potatoes.

MS3 Frost: I'm not in a position to change the menu, but I do have the latitude to use several recipe variations. That prevents meals from becoming monotonous. Small things such as seasoning sauces and dressed-up leftovers seem to be a big hit with the crew. Because crew size is small, I'm able to place more emphasis on serving those items that are to be served hot or cold at their desired temperature.

**Question:** Are you serving in the rating of your choice? And if so, why did you choose it?

**MSSN Doe:** It was my first choice; my dad was a Navy cook years ago, and he said that it was the best rate in the Navy.

**MS3 Frost:** I chose food service as my career field. The MS rating offers both valuable training and an opportunity to gain valuable experience. Whether I make the Navy a career or return to a job in the civilian economy, the skills of operating a dining facility are the same. So you can see, I'm really placing myself ahead. The basic operation of a good dining facility is no different from that of a good restaurant.

Now that we have talked to MS3 Frost and MSSN Doe, let's ask the chief how he rates them.

They are both dependable, but the similarity ends there. MSSN Doe does what you tell him—no more, no less. I guess the main thing in his favor is that you only have to tell him once. MS3 Frost is completely different. He always wants to know why. Not because he wants to argue, but because he wants to KNOW the nuts and bolts of the operation. He is professional in his attitude toward his job. He finds out what makes food service good, and then he tries to make it better.

### EVALUATION OF CASE NUMBER 1

A member's performance is definitely affected by the attitude that is brought to the job. Evaluate both MS3 Frost and MSSN Doe on the following items from the checklist. You should consider their responses to the questions and the chief's comments in forming your evaluation.

Self-Evaluation Checklist

	Are you here?	Or do you need improvement?	
		Some	Much
2	Excellent knowledge of rating		Poor knowledge of rating

MS3 Frost's answers to the questions and the chief's comment showed that Frost had a strong interest in his job and the ability to perform it well. He was interested

in more than just following a recipe card; he was concerned with all areas of food service. MSSN Doe's responses showed that he refused to learn anything more about his job than just enough to get by.

Self-Evaluation Checklist

	Are you here?	Or do you need improvement?	
		Some	Much
7	Accept responsibility		Avoid responsibility

MSSN Doe preferred to let all responsibility rest with the chief. MS3 Frost felt a responsibility to the crew and demonstrated it by learning all he could about his job.

Self-Evaluation Checklist

	Are you here?	Or do you need improvement?	
		Some	Much
9	Pleasant, outgoing, friendly		Surly, argumentative, sarcastic

Both of them rate pretty high on this item. However, MS3 Frost showed more than just a good-natured friendliness toward the crew. He showed an interest in the crew by wanting them to be satisfied with the food as well as the service.

Self-Evaluation Checklist

	Are you here?	Or do you need improvement?	
		Some	Much
14	Genuine interest in customers' problems		Resent problems; they cause work

MS3 Frost indicated his interest in providing meals that the members want to eat. MSSN Doe showed no real interest in pleasing the customers.

Self-Evaluation Checklist

	Are you here?	Or do you need improvement?	
		Some	Much
15	Go the extra step to ensure customer satisfaction		I do my job

The chief rated MSSN Doe on this item: "MSSN Doe does what you tell him—no more, no less." MS3



Frost used his initiative to prevent monotonous meals and plan his preparation so that food would be served immediately after preparation.

The chief rated both men as being dependable; however, he appreciated the extra interest and effort of MS3 Frost. A more direct means of evaluating these men is to ask yourself the following questions: Which one would you rather have preparing the meals that you eat? Why?

## CASE NUMBER 2

It is a cold, blustery Sunday afternoon in Newport. A destroyer has just recently returned from deployment and it is having a good response to visitor's day in spite of the weather.

Dependents and friends of the crewmembers have just enjoyed a sumptuous dinner (compliments of the hardworking food service division). Next on the schedule of events is a movie to be shown on the mess deck for their entertainment. Most of the children and the less adventurous watch the movie, but the more hardy individuals brave the elements to tour the ship.

BMSN Boat and his wife join the tour. It is Mrs. Boat's first visit, and BMSN Boat is proudly showing off his ship. He has shown her around most of the topside areas and is ending the tour on the bridge. Here he names and explains the purpose of the various equipments and explains (probably bragging just a little) how he uses them while steering the ship. Then, deciding that a cup of coffee will make a welcome finish for the tour, they start their return trip to the mess deck.

Mrs. Boat has just started down the ladder when her foot slips and she falls.

The officer of the deck (OOD) turns when he hears the sound of her falling and goes to her. BMSN Boat is already kneeling beside her. "Are you hurt?" he asks anxiously.

"I . . . don't think. . . so. Just kno. . . knocked the breath. . . out of me."

The OOD inquires of BMSN Boat, "Is your wife hurt?"

"I don't think so." Then he asks her, "Do you feel that you could get up?"

Breathing easier, she nods. "If you help me."

BMSN Boat slips his arm beneath her shoulders and starts to raise her. She gasps, "Wait!"

The OOD turns to the petty officer of the watch (POOW), "Pass the word for the Corpsman to lay to the quarterdeck—on the double."

The Corpsman, HM Pistol, arrives immediately on the scene. After being told what has happened, he kneels beside Mrs. Boat and asks, "Are you in pain now?"

"Some . . . Where I hit my back. It hurts when I breathe."

HM Pistol examines Mrs. Boat as quickly as he can and concludes that she has no back injury. "Mrs. Boat," he says, "I'm afraid you have one, possibly two, broken ribs. So as not to move you any more than necessary, we'll make you as comfortable as possible here until the ambulance arrives to take you to the hospital." Turning to the OOD, "I'll need three or four blankets out of sick bay. I'll call for the ambulance."

Mrs. Boat counters, "I can't go to the hospital. There's no one to take care of the baby."

BMSN Boat adds, "I'm in the duty section today."

HM Pistol quickly places the call to the hospital for the ambulance. He explains the probable nature of the injury and the extent of his examination so that the hospital can prepare to receive and treat Mrs. Boat.

As he returns to Mrs. Boat, the messenger arrives with the blankets. Gently, she is placed on one of the blankets and covered with the others. Then, turning to BMSN Boat, HM Pistol asks, "Where is your baby now?"

"A neighbor is keeping her so that my wife could visit the ship."

"Can they keep her for a few more hours?"

"I guess so, but that won't help much. I'll need to take leave."

HM Pistol goes over to the OOD and explains the problem of the Boats' baby. "To complicate matters, Boat is in the duty section today. Can he be given emergency leave until his wife is able to care for the baby? Five days should be sufficient."

The command duty officer (CDO) has been briefed by the OOD and is standing nearby. Overhearing the account of the situation he replies, "Certainly; Boat can go on to the hospital with his wife, and on the way home he can stop by and pickup his leave papers. They will be on the quarterdeck." To the OOD he adds, "Have the leave papers prepared and brought to me for signature, and have the duty section petty officer make the required adjustments to his duty section."

HM Pistol returns to BMSN Boat and Mrs. Boat. "Boat, you are being granted emergency leave for 5 days. We hope that this will be enough time. If not, you may request an extension. You go on with your wife in the ambulance. Then on your way home, stop by and pick up your leave papers—they will be on the quarterdeck. If you would like for me to call your neighbor and explain the situation, just give me the name and phone number."

## EVALUATION OF CASE NUMBER 2

### Self-Evaluation Checklist

	Are you here?	Or do you need improvement?	
		Some	Much
2	Excellent knowledge of rating		Poor knowledge of rating

True, this was a relatively minor emergency, but the proper response to this minor emergency indicated that proper response would be made to a major emergency as well.

### Self-Evaluation Checklist

	Are you here?	Or do you need improvement?	
		Some	Much
7	Accept responsibility		Avoid responsibility

The OOD recognized and respected HM Pistol's responsibility as the Corpsman, and HM Pistol assumed his responsibility easily and efficiently. HM Pistol had confidence in his ability, but he also knew his limitations and when to ask for help.

Very likely, he had anticipated the many situations that could arise from having a number of people aboard who were not familiar with shipboard accommodations, and with this anticipation, he had also considered the appropriate responses. After all, isn't that the purpose of shipboard drills—to anticipate possible situations and to train personnel to meet them? This anticipation is also a valuable part of self-training—to anticipate events that could happen and to be prepared to meet them.

### Self-Evaluation Checklist

	Are you here?	Or do you need improvement?	
		Some	Much
14	Genuine interest in customers' problems		Resent problems; they cause work

Quite often, the contact point representative tends to remain aloof from the customer with the excuse that, "I know what needs to be done, and I'm doing it. The customer should be interested only in results—the mechanics are my business." This attitude may result in some unnecessary surprises for the customer. Since BMSN Boat and Mrs. Boat were understandably anxious about her condition, HM Pistol reassured them as soon as he possibly could. In addition, he did not restrict himself to his professional responsibility, but extended his interest to a personal problem occasioned by the accident.

### Self-Evaluation Checklist

	Are you here?	Or do you need improvement?	
		Some	Much
15	Go the extra step to ensure customer satisfaction		I do my job

HM Pistol's total performance was made outstanding by his extra steps.

## CASE NUMBER 3

Leading petty officer (LPO) Brush leans back in his chair and surveys his smoothly functioning office. All the baskets are empty; all the work caught up. PO Door and SN Christmas are discussing their soon-to-be liberty with eager anticipation. LPO Brush returns to his paperback novel secure in the knowledge that it is going to be a peaceful afternoon. He becomes so engrossed that even a ringing telephone doesn't break his trance until the sixth ring. At that, he says, "One of you #S%& move off your #S%& and answer the #S%& phone."

PO Door picks up the phone. "Personnel office, PO Door speaking . . . Whatya say, Lee? . . ."

SN Christmas looks up at the arrival of a customer. "What can I do for you?"

"I would like to know if you can tell me the qualifications for Radioman School?"

"They don't need any more Radiomen."

“But, the division PO told me that they would before long, and I should start now trying to get in,” he replies.

SN Christmas reluctantly gets up and starts for the file cabinet. “What’s your name?”

“Boate, Jon T. I’m in the deck force now.”

SN Christmas pulls his record and walks to the counts. “Your test scores are not high enough for RM school.” He closes the record and starts back to the file cabinet.

“But, the PO said I could get the scores waived based on the needs of the Navy.” SN Boate has learned quite a bit about the Radioman rating by completing the Navy’s correspondence course for the rating and asking the radio gang a lot of questions—he doesn’t want to miss his opportunity to become one of them.

“Everybody’s a #S%& expert!”

SN Boate stammers, “He said you waived the scores for. . .”

“Put in a chit! It’s no skin off my nose. It won’t be approved.” He replaces the record in the file and returns to his desk.

“Why?”

“#S%&, we can only waive 10 points, which won’t do you any good.”

LPO Brush, finally disturbed by the rising voices, looks up from his book and glares at SN Boate, “We don’t tell you how to chip the #S%& deck don’t try to tell us how to do our #S%& job! You heard what Christmas said. Now quit bothering him; he’s got work to do.” SN Boate turns and walks away.

LPO Brush shakes his head as he says, “These guys today; no respect at all.” He returns to his book, and Door and Christmas resume their discussion of their anticipated liberty.

A few minutes later, PO Seaman enters the personnel office. He has finally received his long awaited orders for shore duty. He has only been transferred twice—to school and then to the ship. Since then he has become a husband and father. Both PO Seaman and his wife are looking forward to the tour of shore duty, but both has several unanswered questions about transferring with dependents. So, PO Seaman enters the personnel office and says, “Hey, Door, you got my orders typed up yet?”

PO Door comes over to the counter. “Not yet. What’s your hurry? You won’t be leaving for another month.”

“What will my detachment date be?”

“I haven’t figured it out yet. It depends on how much leave you take and how much travel time is allowed.”

LPO Brush looks up from his book, “Door, haven’t you typed his orders? You’ve had them for 2 weeks.”

“We’ve been busy. I’ll get it now, Brush. How much travel time and leave does he get?”

“Look it up! I thought your work was all caught up.”

“I’ll be caught up by the time they sound liberty call.”

LPO Brush snorts, “You will be caught up before your liberty starts. PO Seaman, can you come back in about an hour? That should give these geniuses enough time.”

“I guess so. Say, I am going to have some furniture to ship. Do you take care of that?”

“Naw. Check with Supply. They should have some answers for you.” As PO Seaman leaves the office, LPO Brush goes back to his desk, muttering, “If you want anything done right, you can expect to do it yourself.”

### EVALUATION OF CASE NUMBER 3

#### Self-Evaluation Checklist

	Are you here?	Or do you need improvement?	
		Some	Much
2	Excellent knowledge of rating		Poor knowledge of rating
3	Good work organization		Poor work organization
4	Office/personnel records in top condition		Office personnel records sloppy

Other than the somewhat careless approach to preparing PO Seaman’s orders, there is not much basis for marking these items. However, LPO Brush would probably give the office a high rating. After all, he thought his office was functioning smoothly.

**Self-Evaluation Checklist**

	Are you here?	Or do you need improvement?	
		Some	Much
6	Good command of English (written and oral)		Poor choice and use of words

Excessive use of profanity is generally considered a vocabulary weakness. The use of profanity by Brush and Christmas did not improve communications; as in most cases, it impaired it. They might have felt that the use of profanity strengthened or emphasized the thoughts or ideas they were expressing, or profanity may have become a speech habit that they used without being aware of it.

**Self-Evaluation Checklist**

	Are you here?	Or do you need improvement?	
		Some	Much
7	Accept responsibility		Avoid responsibility

PO Door was shirking his responsibility for carrying out his assignments, and LPO Brush was lax in carrying out his supervisory responsibility of following up on the work assignments he had made.

**Self-Evaluation Checklist**

	Are you here?	Or do you need improvement?	
		Some	Much
9	Pleasant, outgoing, friendly		Surly, argumentative, sarcastic

As contact point representatives, they have very little in their favor on this item. SN Boate would rate them very low, and PO Seaman probably would say that they are pretty good at making excuses.

**Self-Evaluation Checklist**

	Are you here?	Or do you need improvement?	
		Some	Much
11	Treat all customers with equality/fairness		Take good care of friends

They strike out again. They demonstrated neither equality nor fairness in dealing with customers.

**Self-Evaluation Checklist**

	Are you here?	Or do you need improvement?	
		Some	Much
12	Give customers only correct information		Give them an answer and get rid of them

The information given to SN Boate may have been correct, but they made no effort to convince him. They only intimidated him into accepting it. PO Seaman will need quite a bit of information before he completes his first transfer with dependents and personal effects, but no doubt he will seek it elsewhere.

**Self-Evaluation Checklist**

	Are you here?	Or do you need improvement?	
		Some	Much
13	Considerate of customers' time		Only considerate of own time

An interesting conversation during a personal call is not sufficient reason to delay answering the phone until after the sixth ring. PO Seaman had made at least two trips to the personnel office and would have to make a third to find out what his detachment date would be.

**Self-Evaluation Checklist**

	Are you here?	Or do you need improvement?	
		Some	Much
14	Genuine interest in customers' problems		Resent problems; they cause work

Their only interest in SN Boate was ridding themselves of him and his problem. Both displayed a lack of interest and concern for his desire to choose a rating. PO Door did not consider it necessary to prepare PO Seaman's orders immediately—he felt he had plenty of time. He failed to recognize that the Navy member had responsibilities outside of the Navy. Advance planning is required when a service member has dependents to be relocated—dates are all-important to this planning.

### Self-Evaluation Checklist

	Are you here?	Or do you need improvement?	
		Some	Much
15	Go the extra step to ensure customer satisfaction		I do my job

The extra step in this case would have been to fully explain what was standing in SN Boate's way of becoming a Radioman. In addition, they could have informed him that retesting was possible under certain conditions and that he might strike for the rating without a school. However, they should have informed him of the handicap that he would face if he didn't receive the advance technical training. In PO Seaman's situation, they should have been able to volunteer information that would make his planning easier.

### CASE NUMBER 4

As SN Frost enters the personnel office, PN Doe looks up from her work and asks, "May I help you?"

"I hope so. All my friends are PO3, and I can't even take the test."

"Why?"

"That's what I want you to tell me. I think it's just because my division officer doesn't like me. Can you do anything?"

PN Doe may be able to do a lot of things, but, at this point, helping SN Frost is not one of them. She still doesn't know what SN Frost's specific problem is.

PN Doe says, "Just a minute. Let me get your record." Getting the record from the file, she begins turning the pages. Recommended? No. Performance evaluation? Good. Training completed? Yes. Personnel advancement requirements completed? Now she knows the problem. SN Frost has not completed his PARs for advancement. "The only thing holding you back is the completion of your PARs. Have you asked your division officer about that?"

"Yeah. He said something about it the other day, but I told him I'd already completed it before I transferred here. He acted like he didn't believe me."

PN Doe picks up the phone and locates SN Frost's division officer. "Mr. Brush, this is PN Doe in the personnel office. I am checking SN Frost's record. Do you have his personnel advancement requirements?" She listens for awhile, thanks Mr. Brush, and hangs up.

"Mr. Brush said that your last command didn't send your PARs, and he had made up a new one. The command never entered the completion on your page 4 either, I will write to your previous command for the record. We can hope that it hasn't been lost and that we will receive it before the cutoff date for this exam. In the meantime, I suggest that you talk to Mr. Brush. Tell him the situation, and start completing the PARs for PO3—just in case. There is still time for you to be recommended so that you will be able to take the examination."

### EVALUATION OF CASE NUMBER 4

#### Self-Evaluation Checklist

	Are you here?	Or do you need improvement?	
		Some	Much
2	Excellent knowledge of rating		Poor knowledge of rating

A knowledge of the PN rating is only one part of the PN's job. PN Doe's confidence indicated a good working knowledge of the rating.

#### Self-Evaluation Checklist

	Are you here?	Or do you need improvement?	
		Some	Much
13	Considerate of customers' time		Only considerate of own time

SN Frost's time spent in coming to the personnel office was not wasted. He received the help he needed when he needed it.

#### Self-Evaluation Checklist

	Are you here?	Or do you need improvement?	
		Some	Much
14	Genuine interest in customers' problems		Resent problems; they cause work

Instead of picking up the phone and calling Mr. Brush, it would have been easier for PN Doe to say, "Your PARs have not been entered in your record. Go see your division officer." SN Frost was distrustful of his division officer; he felt that Mr. Brush's dislike for him was the reason he couldn't take the examination for PO3. PN Doe's interest "bridged the gap" somewhat by refuting this suspicion.

### Self-Evaluation Checklist

	Are you here?	Or do you need improvement?	
		Some	Much
15	Go the extra step to ensure customer satisfaction		I do my job

PN Doe was doing all that she could for SN Frost. However, her explanation of what had happened, what action she was taking, and what SN Frost should do as an alternative was just as important to the customer's satisfaction.

The value of the "extra step" is difficult to measure, but its effect is easily seen.

### CASE NUMBER 5

PO Seaman recently completes a tour of overseas shore duty and he is now on CONUS shore duty at a small station served by the disbursing officer of an activity some distance away. On his previous assignment he and his wife lived in government quarters. Before leaving his previous station, PO Seaman had started an allotment to his wife and had it sent to her parents' address.

PO Seaman isn't surprised when he does not receive a check on the first payday after reporting in; nor is he too concerned when he draws a blank on the second, since his wife has started receiving her allotment checks.

When the third payday still brings no check, he decides that he has waited long enough. He takes his problem to the administration office, and the YN places a call to the disbursing office.

The YN explains to the DK that PO Seaman has now been aboard almost 2 months and has not been paid during that time. The DK obtains PO Seaman's Personal Financial Record and informs the YN that PO Seaman has no pay coming—he is actually overpaid.

"When will the overpayment be liquidated, and when will he receive a check?" the YN asks.

The DK replies, "At the rate he's going—never. He is going deeper in the hole each month."

PO Seaman has heard enough to know that something is wrong. "May I talk to him?" he asks. Taking the phone, he identifies himself and asks what the problem is. The DK gives him a breakdown of credits and deductions. PO Seaman adds them up and exclaims, "Something's wrong! The DK at my last

station said I would draw around \$50 a payday. Are you sure you gave me all the figures?"

"I've given you everything on your LES. Say, are you married?"

"I sure am. That's who the allotment is going to."

"Why aren't you getting BAQ" asks the DK.

"That's a good question. You answer it."

"We can start it now. You'll have to submit an application for BAQ."

"What for? I've been married 5 years. You mean that isn't on my record?" PO Seaman is becoming angry.

The YN motions for the phone and PO Seaman gives it to him.

"Let me speak to the disbursing officer to see if we can straighten this out," he tells the DK.

The DK is glad to oblige; he can't see why PO Seaman is so excited.

When the disbursing officer answers, the YN explains the problem and asks for advice. It doesn't take the disbursing officer long to conclude what has happened—the housing office had not provided the pay order that would have started PO Seaman's BAQ effective the day following his departure. He tells the YN, "Send us a pay order starting PO Seaman's BAQ as of the day he reported. That will take care of the overpayment, and we will send a check for the balance. In the meantime, we will send a letter to the housing office at his former command to request the pay order that should have been provided before he left. As soon as we get that, a check will be issued to cover the balance of PO Seaman's back pay."

### EVALUATION OF CASE NUMBER 5

Several actions and failures could be evaluated in this case, but let's concentrate on the response given to the remote customer.

### Self-Evaluation Checklist

	Are you here?	Or do you need improvement?	
		Some	Much
14	Genuine interest in customers' problems		Resent problems; they cause work
15	Go the extra step to ensure customer satisfaction		I do my job

Facing the customer across the counter isn't always possible; many customer contacts must be handled by telephone. Extra effort is required in these cases to ensure that the contact doesn't become impersonal. Remember, that is a person on the other end of the line—not just a voice!

The DK had lost sight of that fact. He was concerned only with a pay record and a voice.

The disbursing officer could have passed the responsibility back to the YN. The officer could have told the YN to write for the pay order and that PO Seaman's pay would be corrected after it was received. Until then, PO Seaman would have continued his payless paydays. However, he proposed an immediate, partial remedy, even though it would involve additional work for his office. Thus, PO Seaman had the satisfaction of knowing that part of the problem was being corrected THEN. He also explained the additional steps he would take to completely clear up the problem.

**CASE NUMBER 6**

It had been one of those extremely hectic, tiring days, and PO Brush and SN Pistol were still busy with the last two customers. No one else was waiting, so maybe these customers would be the last for the day. Suddenly their work was interrupted by the sound of a hand slapping the counter and the demand, "A little service here !"

PO Brush muttered under his breath, "A little service is all you'll get." Aloud he said, "Be with you in a minute." He then returned to the customer he was helping.

"Come on! Come on! I haven't got all day!"

SN Pistol replied, "Neither have we. Just 10 more minutes to quitting time."

"Just once, I would like to come into this office without having to stand around and wait."

PO Brush replied, "Did you know that we schedule our busiest part of the day to coincide with your arrival. We were all frightened that you will come in and not have something to gripe about."

"I believe it." To show his further irritation, he then began humming and tapping his fingers on the counter, After awhile he asked, "Why don't you get into a good rating?"

"Such as?"

"Anything but this. Boy, what a waste of time! You guys sit in here all day and twiddle your thumbs."

"What do you want?" SN Pistol asked.

"GO ahead, finish what you're doing. Don't let me interrupt you."

PO Brush finished with his customer and turned to the noisy customer, "Now, what can I do for you?"

"Ah, it's too late now. I'll come back in the morning."

PO Brush was beginning to steam. "You do that. Come in at 0800. Then instead of waiting only 5 minutes, you can wait all day."

**EVALUATION OF CASE NUMBER 6**

Unfortunately, the checklist does not apply to customers.

**Self-Evaluation Checklist**

	Are you here?	Or do you need improvement?	
		Some	Much
9	Pleasant, outgoing, friendly		Surly, argumentative, sarcastic

At the end of a busy day and faced with a customer such as this, anyone would have difficulty in maintaining a pleasant, friendly manner. However, nothing is gained by "cutting the customer down" or permitting him to control your temper. Because the customer did aggravate them, PO Brush and SN Pistol would have to make a diligent effort to be pleasant and friendly toward him when he returned the next day.

**CASE NUMBER 7**

The phone rings and rings and rings and rings.

"D'sbursingofficePistolspeakinsir."

SA Doe, hopeful that he has reached the disbursing office, states his problem, "I have been granted emergency leave starting at 1600, and I don't have enough money to make the trip. One of my friends told me I could get special pay. Can I?"

"Ya'llhaftacomeuptotheoffice." Click!

SA Doe charges up to the office and presents himself at the window. The DK looks up from his desk, "Whatayawant?"

"I just called about special pay, and you said to come on up to the office."

"How much ya need?"

SA Doe thinks to himself, This is great! I was afraid I wouldn't have enough money to get home. Now I'll be able to take a plane. He answers, "\$300 will be plenty."

"Where's your chit?"

SA Doe is taken aback. He looks questioningly at the DK

"Wha—"

"Your special request chit; the XO has to approve it."

"Oh, I didn't know," SA Doe mumbles.

"Well you know now."

SA Doe heads for the division office where he obtains the special request form and fills it out; then he heads back to his division PO for the first signature. PO Boate is helpful in getting his leave approved, and he takes the special pay request to the division officer and the department head. PO Boate explains that the reason SA Doe didn't submit the request earlier was because he was not familiar with the procedures for obtaining special pay. The head of the department approves the request and says that he will take it to the XO to save time.

SA Doe soon has his approved request, and he returns to the disbursing office to get his money. Just as he reaches the office, the DK comes out, closes the door, and locks it.

"Excuse me, when can I get my money? I have the special request approved?"

"I'm gonna eat. Come back after 1300."

At 1300, SA Doe is standing by the door waiting for the DK to return. As the DK approaches, his first words are, "Are you here again?"

"Yes sir. You said to come back at 1300."

"Come on in. If I don't get you outa my hair, I'll never get nothin' done."

The DK takes Doe's special request and goes to the file to pull Doe's financial record. He keeps up a constant one-sided conversation to impress SA Doe with all the work he has to do, the extra work caused by the

special pay request, and the fact that if he wasn't such a nice guy he wouldn't bother with it at all.

"Where'd you get the idea ya had \$300 coming? The most you can draw is \$200."

"I don't know. You asked me how much I wanted. With \$300, I could fly."

"O, boy!! I oughta throw the whole works in the can. Do you want the \$200?"

"Yes sir."

Later, as SA Doe finishes packing, he confides his financial problem to a friend and asks if he can borrow some money from him to be repaid when he returns. His friend says he doesn't have any extra, but he has heard of one man who obtained a loan from the recreation fund.

SA Doe again seeks out PO Boate and asks him about the possibility of getting a loan from the recreation fund. PO Boate goes with him to see the recreation fund custodian and vouches for his need. Only a short time is needed to arrange for the loan of \$100.

## EVALUATION OF CASE NUMBER 7

All's well that ends well? Let's consider PO Boate's performance first.

### Self-Evaluation Checklist

	Are you here?	Or do you need improvement?	
		Some	Much
12	Give customers only correct information		Give them an answer and get rid of them
13	Considerate of customers' time		Only considerate of own time
14	Genuine interest in customers' problems		Resent problems; they cause work

He was very helpful each time SA Doe approached him. But were there three problems or just one problem that required three trips to solve? SA Doe only had one problem—to get home on emergency leave. Sure, PO Boate was helpful, but wouldn't he have been more of a help if, when presented with the leave request, he had asked, "Do you have enough money to make the trip?" His greater knowledge and experience could have



provided that information which SA Doe spent most of the day discovering.

So, we find that PO Boate didn't do so well. Not because of what he did, but because of what he did NOT do. His concern was with the immediate problem—he did not anticipate possible complications. As a result, Boate, SA Doe, the head of the department, the XO, and the DK all wasted time.

Now let's look at DK Pistol's performance.

**Self-Evaluation Checklist**

	Are you here?	Or do you need improvement?	
		Some	Much
6	Good command of English (written and oral)		Poor choice and use of words

He spoke clearly in face-to-face conversation, but not on the phone. Some people speak on the phone as though they were being charged by the minute—they crowd as many words into as little time as possible. That is particularly true when people are answering the phone or repeating frequently used phrases. More attention to grammar and diction will improve telephone communications considerably.

**Self-Evaluation Checklist**

	Are you here?	Or do you need improvement?	
		Some	Much
9	Pleasant, outgoing, friendly		Surly, argumentative, sarcastic

He has much room for improvement. His general attitude was Don't bother me!

**Self-Evaluation Checklist**

	Are you here?	Or do you need improvement?	
		Some	Much
12	Give customers only correct information		Give them an answer and get rid of them

The information he gave was correct, but he stopped too soon. SA Doe was misled because the DK didn't

want to give Doe any more information than was absolutely necessary.

**Self-Evaluation Checklist**

	Are you here?	Or do you need improvement?	
		Some	Much
13	Considerate of customers' time		Only considerate of own time

He had several opportunities to avoid wasting his and SA Doe's time, but he missed all of them.

**Self-Evaluation Checklist**

	Are you here?	Or do you need improvement?	
		Some	Much
14	Genuine interest in customers' problems		Resent problems; they cause work

Probably his lack of interest was his basic failure. Because he was not interested in the customer, his approach was to handle the immediate problem with the least amount of effort.

**Self-Evaluation Checklist**

	Are you here?	Or do you need improvement?	
		Some	Much
15	Go the extra step to ensure customer satisfaction		I do my job

He was not really interested in the welfare of the customer—he did only what he had to do.

**CASE NUMBER 8**

A Hospitalman going over a patient's chart in the orthopedic clinic answers the phone, "Orthopedic Clinic, HM Door; may I help you?"

Over the line comes an irate voice, "This is Captain Boat, retired, and I'm really upset. What's going on there? I was referred by primary care to see an orthopedist. Someone at the appointment desk told me it will be 2 months before I can get an appointment. What? Are you kidding! I thought I was to get all of this great care in the military. Is this what you call care? I fought in two wars and gave 30 years of my life to this

country. I was promised health care for the rest of my life.”

HM Door sympathizes, “You sound very upset, Captain Boat.”

“You bet I’m upset. Now I want to know if you’re going to do something?”

“Yes sir,” answers HM Door, “I’m going to help you get the care you need, but first I’d like to explain the situation.”

“Go ahead and explain; I’m listening, but you’d better make it good.”

“Captain Boat, I understand your frustration in trying to access our system. However, we simply don’t have the number of appointments needed to accommodate the enormous volume of patients requesting them.”

“What, are you kidding?” responds the Captain, “I’ve always gotten my health care at the base hospital.”

HM Door continues, “Sir, we do have options for alternative care if you prefer not to wait for a space-available appointment. Our Health Benefits Advisor, Lt. Mary Christmas, can explain these options. She’s the person at the hospital that can solve problems like yours. Would you like to talk with her, Captain Boat?”

“I am having so much elbow pain that I guess it does make sense to talk to someone who can help me get care.”

“I can transfer your call to her right now. Let me give you her phone number in case we’re disconnected. The number is 123-4567.”

“Health Benefits Officer, Lt. Christmas, may I help you.”

“This is Captain Boat, I retired from the service after 30 years and have been seen many times at the base hospital. I have a referral from primary care to see an orthopedist, but I was told that there were no available appointments for at least 2 months.”

Lt. Christmas responds, “I’m glad you called me, Captain Boat, I can help you locate an orthopedic physician in the local community through our Health Care Finder Program or through our Partnership

Program using your CHAMPUS benefits. Would you like me to explain these two options to you or discuss the benefits offered through CHAMPUS.”

“Perhaps I should come to the hospital to talk with you. I’ll be on the base this afternoon—can I see you then?”

“You sure can. We’re located on the first floor in the patient administration section. I’m looking forward to meeting with you.”

“Thank you, I’ll be there by 1400.”

## EVALUATION OF CASE NUMBER 8

Self-Evaluation Checklist

	Are you here?	Or do you need improvement?	
		Some	Much
15	Go the extra step to ensure customer satisfaction		I do my job

In a health care environment, there will always be some angry patients, problems with family members, and problems with the health care staff. Many of these problems are unique to this profession. After all, few people want to be patients. This in turn, creates an excellent environment for emotional and mental stress.

This case is a example of how positive communication can be used to turn a hostile encounter into a neutral, if not a pleasant, one. Captain Boat was upset because he was unable to get an appointment to see an orthopedic physician. Such encounters happen daily at military facilities when services to retirees are limited.

Going the extra step to ensure customer satisfaction is only one part of the HM rating. The actions of Lt. Christmas and HM Door indicated that they did take that step. First HM Door reacted patiently and sympathetically with Captain Boat. He then transferred Captain Boat’s call to the patient administration section to have the problem resolved. Lt. Christmas offered to help locate a physician in the local community that could take care of the captain’s problem. She then went a step further by offering to explain the benefits available through CHAMPUS.

## CHAPTER 3

# MANNING THE CONTACT POINT

### LEARNING OBJECTIVES

*Upon completion of this chapter, you should be able to do the following:*

- *Discuss the first impression of your initial approach when handling customers' needs.*
- *Discuss pitfalls to avoid when handling customers' problems.*
- *Describe what you can do and what you should do to avoid dissatisfaction in extreme and unusual situations.*
- *Discuss why assisting the customer is important.*
- *Discuss the importance of working with records of customers.*

---

You often hear the lament, “No one notices the things I do right, only the things I do wrong.” Unfortunately, that is too often true! Perhaps that occurs because we expect people to do things right or because we find it easier to pick out those things that are wrong and evaluate their consequences. To emphasize this point, we use examples and illustrations in this book that point out mistakes you can avoid.

Chapter 1 listed several contact points to which customers could come to receive services. These may be personal services, specialized services, or routine services.

The customer who wants to request a school, register an allotment, correct a service record error, or discuss a personal problem requires more than routine, impersonal service. You should treat that customer as an individual with a special need.

Most customers have routine needs that can be met on an impersonal basis. For example, the post office sorts mail for delivery; on payday the disbursing officer verifies and distributes pay—both are routine services. Even though routine services are impersonal, that doesn't mean they are unimportant; they are both personal and important to the customer receiving them. Performing all routine services properly eliminates many customer service problems.

This manual does not attempt to present customers' problems and their solutions. Rather, it identifies

problems in personal interactions, discusses factors that influence attitudes, and suggests ways to improve your effectiveness.

### THE INITIAL APPROACH

It has been said that the first impression is a lasting impression. Upon first meeting someone, you quickly form opinions based on that person's dress, speech, mannerisms, and rating or rate (if known). These first impressions are not always fair, but they do exist; they do affect our attitude.

### MAKING A GOOD FIRST IMPRESSION

Customers form a first impression about you based on the same criteria you use to form your first impression of them. However, these impressions affect your customers differently than they affect you. You will extend service to numerous customers during the course of a day—you meet a customer, form an impression, provide a service, and then redirect your attention to the next customer. The impression you form may affect your mood, but it usually does not extend beyond the individual customer or group of customers.

On the other hand, a customer's impression of you usually gets generalized to the entire office. For example, a customer has a particularly complicated problem, and you are able to solve it by looking up the

applicable references. The customer may make a comment to his or her shipmates such as, "That disbursing office is on the ball. The people in that office know what they're doing."

**Presenting a Good Appearance**

The first thing the customer notices and uses in forming an impression is appearance. Appearance includes not only your personal appearance, but also the appearance of the contact point.

The appearance of the contact point reveals your attitude toward the job you are doing. A neat, efficient-looking, businesslike working space implies that the people working there are efficient and businesslike, but a space that has a patchwork appearance has the opposite effect. Although an unkempt appearance may not affect your performance, it can affect the customer; the following are some examples:

<u>APPEARANCE</u>	<u>AFFECT ON CUSTOMER</u>
Spilled food on the steam table	I wonder what the galley looks like?
Service records scattered around the personnel office	I wonder if one of those is mine?
Hospital Corpsman's uniformed soiled	I hope the needle was cleaner than that.

A careless attitude toward your appearance makes a customer feel you might also be careless about the service you provide.

**Projecting Your Attitude**

The customer forms a mental picture of you based on your attitude. Your attitude is a message about your mood, feelings, and opinions that you unconsciously communicate. Through your attitude, the customer soon realizes how you feel. You don't have to express your feelings in words because your attitude expresses them for you—and it doesn't take long. Your attitude shows how you view your job, your rating, the Navy, the customer, and the customer's problem.

**TOWARD YOUR JOB, YOUR RATING, AND THE NAVY.**— The following shows the difference in a negative and a positive attitude by two people in the same job:

<u>NEGATIVE ATTITUDE</u>	<u>POSITIVE ATTITUDE</u>
I wish I could get out of this rat race.	I perform an important function by providing needed services.
They treat me like a servant.	We are all members of the same team.
I'm tired of this little dinky job.	This job is never boring. I learn something new everyday. What I do and how I do it is important to the customer.

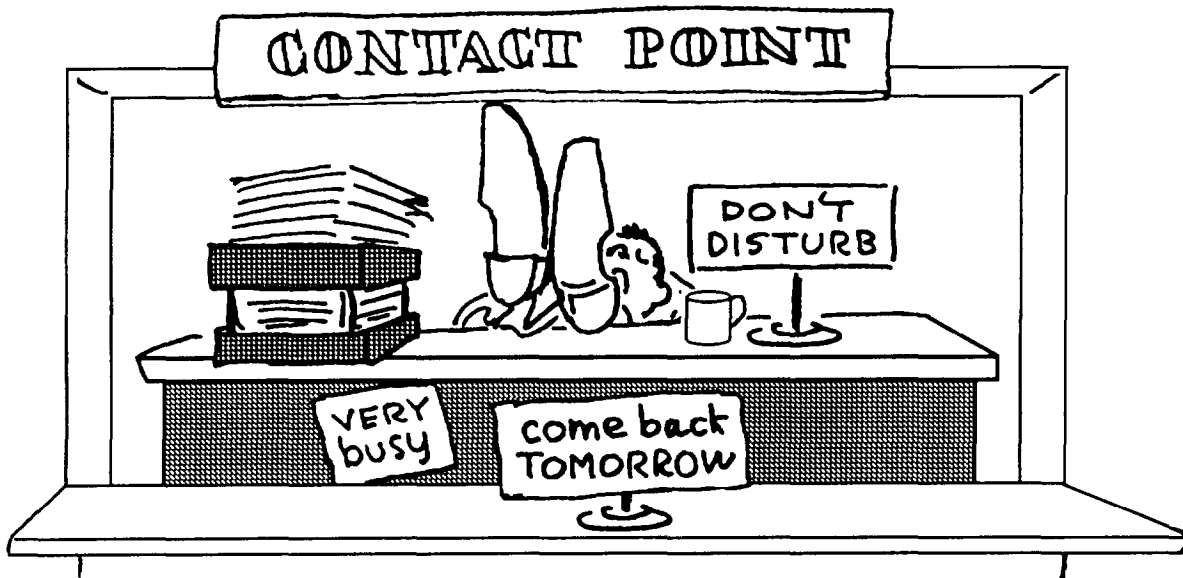

NEGATIVE ATTITUDE POSITIVE ATTITUDE

Those dumb kids don't know what they want.	Because of these kids' inexperience, I can see the importance of my services.
Don't bother me!	May I help you?

If you have a negative attitude toward your job, have you stopped to ask yourself why, and what can be done about it? Consider the following examples:

Are you in a job that doesn't fully challenge you. Do you have too much time on your hands? Use this time as an opportunity to sharpen your skills to better serve at your particular contact point. You may even start looking at the demands of jobs that are more responsible. Tolay's Navy is becoming smaller; and along with that, the number of people who are willing to do more than the bare minimum is becoming smaller. Those who are willing to do more are far from being suckers. They are special in the sense that they obtain satisfaction from doing their job well.

Do you view your job as being routine? Do you think it offers no challenge? If either is true, research the overall purpose or objective of your job to see how it fits into the mission of your activity or command. You will not only gain an appreciation for the importance of your job, you may qualify yourself for a more responsible position.

If you are job dissatisfied, look around for a job you would prefer. The next step would be to qualify yourself for that job. To illustrate this fact, supply was fortunate to have a conscientious SKSN. He had mastered several rather complex accounting procedures through research, practice, and personal guidance. Because of his initiative, when the SK1 assigned to the accounting department was transferred, the SKSN was immediately assigned his duties. The SKSN saw the job as a challenge and worked hard to get it—so can you.

Regardless of how you answered these questions, you will nevertheless communicate your attitude toward your job to your customers. Your customers will quickly sense your attitude from your speech and manner.

**TOWARD THE CUSTOMER.**— Your attitude toward the customer relates closely to your attitude

toward your job. The customer quickly senses your attitude from your speech and manner.

Have you ever ignored customers when they entered your office to try to impress them with how important or how busy you were? Were the customers impressed? No doubt! But, not as you may have expected. They were probably more impressed with your lack of concern for their needs.

When a customer comes to you for help, a perceived level of confidence in your ability to provide it already exists. Offensive language or a superior attitude will quickly undermine this confidence.

“Speaking down” implies that you consider the customer to be less than your equal. That attitude may make the customer feel that the service you provide is less than your best. The language you use can give the impression that you are speaking down, so avoid using language that might be unfamiliar to customers. You need to know what language to use, when to use it, and how to use it. When engineering or deck division personnel come into the office for information, you must use words they can understand.

We will speak more about stereotyping later but for now, we want to issue a word of caution about its effect on the customer. Stereotyping is the practice of fitting people and things into preconceived molds. For Navy members, it is also the practice of fitting members of ratings or occupations into an established “norm.” The fallacy of this practice is that hardly anyone fits into that norm. The best way to avoid stereotyping is to recognize the contribution each rating makes to the Navy. True, a person outside your rating may not understand every aspect of your specialty; but how proficient are you in that person's specialty?

Try to identify whether you have the habit of stereotyping your customers. Then take steps to overcome that habit. Though you may not be aware of the habit, the CUSTOMER IS AWARE OF IT.

**TOWARD THE CUSTOMERS' NEEDS.**— The customers' needs will span the continuum from the ridiculous, through the routine, to the difficult. However, these categories reflect your opinion of the needs and requests—not the customers'. These needs, requests, and problems are important to customers; otherwise, they would not be there.

You must do more than show a positive attitude toward your job and the customer; you must also show respect for the person's need for service. Disrespectful comments, such as the following, indicate that the customer's request is not important and that you have better things to occupy your time:

Everybody knows that!

You came all the way up here for that?

You didn't know!

You were supposed to be here yesterday.

We'll get to it.

Case Number 3 illustrates the effect of disregarding the customer's need. SN Boat may not have been eligible to strike for RM, but the response he received was not satisfactory. Instead of intimidating SN Boat into believing he couldn't qualify for RM, SN Christmas should have explained the qualifications required. LPO Brush should never have allowed or taken part in such treatment of a customer. Had they given SN Boat the answers he needed, they could have met his needs even though they couldn't give him the answer he wanted.

## MEETING CUSTOMER NEEDS

In the preceding chapter we presented various case studies to help you analyze the effects of your actions as a contact point representative. These analyses were intended to help you see yourself from the customers' point of view and to help you answer the question, Am I providing good service? In most of the case studies, when the customers began seeking help, they were in a good mood, had trust in the ability of the contact representative, and were willing to accept the representative's solution. In reality, that is not always the case.

Trying to meet a customer's needs involves several obstacles: coping with a negative attitude, maintaining self-control, determining the specific cause of the problem, and identifying contributing causes. These obstacles can complicate the customer's problem and your efforts to provide a solution.

## Coping With a Negative Attitude

Regardless of the nature or seriousness of a problem, a customer's negative attitude can complicate it. The customer may

be angry, worried, or frustrated;

lack confidence in your rating; or

be unwilling to accept anything less than the desired solution to a problem.

If you can recognize such attitudes and make appropriate allowances for them, you may avoid further complicating the customer's problem.

An angry, worried, or frustrated customer may have difficulty in stating a problem accurately or completely. The customer may omit significant information, confuse opinion with fact, or refuse to give personal information.

To meet the needs of a customer with a negative attitude, first try to determine the cause of the problem and then target why the customer is emotionally upset. (What caused the anger, and toward whom is it directed?) You can sort this out by letting the customer express his or her feelings.



The adage "The customer is always right" is not always true. No customer has the right to personally abuse a contact point representative. However, the customer who is allowed the opportunity to "blow off steam" (within reason) may then become apologetic and ready to accept your help.

When faced with an upset customer, remember that your purpose is to serve the customer's needs. Any other

response on your part may serve to justify the customer's negative attitude.

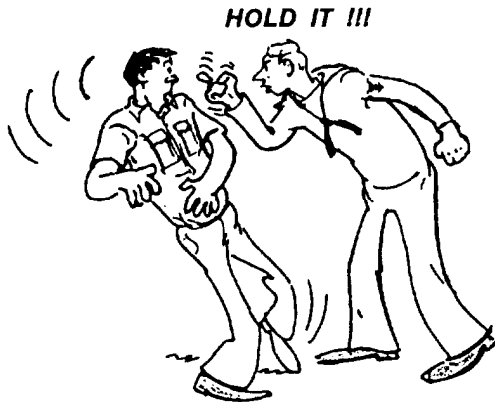

A calm, confident manner is the best approach. When you do not respond with anger or rudeness to a customer's emotional outburst, you have taken the first step toward solving the customer's problem, whatever its nature.

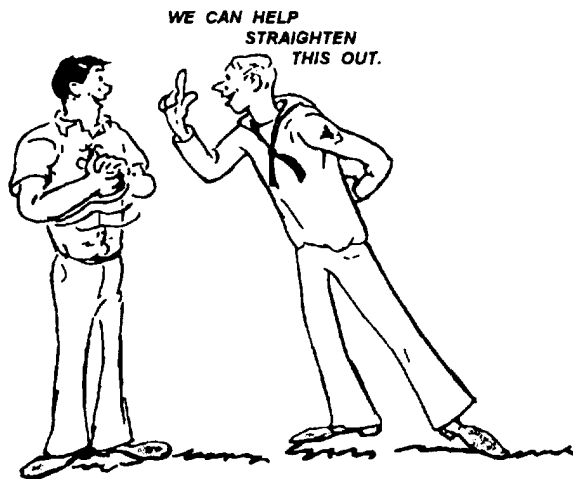

### **Maintaining Self-Control**

Earlier when we discussed your attitude toward customers, we were talking about customers in general. Although personal interaction isn't difficult when your customers are pleasant, it may become difficult when the person is unpleasant.

Occasionally, you will have a customer who seems to rub you the wrong way. No matter how hard you try, you can't remain pleasant or friendly because of the customer's attitude or manner of speaking. In this situation the best solution is usually to keep the contact

as impersonal as possible. Ignore the customer's manner and attitude and concentrate on the problem.

Your performance is viewed by the customer, your coworkers, and your supervisor. For them to rate you as a person who does your best work, you must maintain self-control. Running out of patience and allowing your temper to flare reduces your ability to think and act properly.

### **Determining the Specific Problem**

Frequently when customers have a need, they tell you the results they want instead of telling you the problem; you then must identify the nature or cause of the problem and provide a satisfactory solution. Case Number 4 is an example of this situation. In this example, SN Frost wanted to know why he wasn't allowed to take the advancement examination so that he could advance to PO3. Before the PN could answer that question, she first had to identify SN Frost's specific problem.

You must be familiar with all areas of your rating to be able to identify specific problems and to know where to find specific answers. For example, to identify a specific health problem, medical personnel must know the symptoms of certain illnesses. Once they have identified the illness, they must know where to find solutions to treating the illness. In the same way, you must be able to identify the real problem behind the customer's actions and words. Once you have identified the problem, you must know where to go for a solution.

### **Identifying Contributing Causes**

Most customers have routine, easily identifiable problems. You can solve these problems without any great difficulty. However, there are exceptions, such as in Case Number 5. In this instance, a problem of no pay resulted from an error that had occurred at the previous command. The problem was further complicated by the customer's emotions. To solve the problem, both the customer and the contact point representatives had to have a mutual desire to achieve results. The YN and the disbursing officer had to identify the problem and then take positive action to correct it.

Contact point representatives must be especially alert at all stations that serve as home ports for ships. Because it's natural for ships to deploy, it is just as natural for the home port to be a massive contact point for spouses remaining behind. All Navy spouses will vouch that everything generally runs smoothly until the ship disappears over the horizon. Then the roof caves in! When both partners—husband and wife—are at home, both can work jointly to solve problems; but when alone the spouse must handle the problems the best way possible.

A Navy spouse, husband or wife, has a strong influence on the decision of the member to reenlist (ship over) or return to the civilian sector. That is not unreasonable. After all, the problems that arise in a marriage are best handled by both partners.

When the husband or wife is absent because of deployments, training, or upkeep, the spouse may be unfamiliar with Navy procedures or with the area. These unknowns may further complicate problems that already exist. The Navy spouse doesn't need added complications to an already stressful situation. This is no time for wrong answers or indifferent service. Therefore, when your customers are Navy dependents, make sure they receive the services to which they are entitled.

### **PITFALLS TO AVOID**

In the previous section we discussed why a good attitude is important to customer satisfaction. We will now consider some specific mistakes you might make as a contact point representative in handling customer needs. These mistakes grow out of negative attitudes toward the customer, the customer's problem, the Navy, and their job.

### **JUMPING TO CONCLUSIONS**

Quite often you may jump to a conclusion because you feel you have all the facts needed to make a decision. But when you jump to a conclusion, you are actually making a decision based on incomplete information. It is like having one half of the pieces to a puzzle! When you do that, you often ignore additional information provided by the customer.

Jumping to a conclusion for routine needs might save time, but it can lead to misunderstanding. When you make assumptions, you quit listening and begin to organize your thoughts for your response to the customer. As a result you may miss information that could be important to solving the problem. Because of your misunderstanding, you then may be unable to provide the correct service.

You have a better knowledge of your field than the customer has. Therefore, you might assume that you know the customer's need before the customer finishes expressing it.

Earlier, we discussed the customer who has only a vague idea about the nature of a problem. Conclusion jumping seldom helps this type of customer. You have to use tactful, skillful questioning to properly identify what this customer is trying to tell you.

Case Number 7 illustrated some conclusions arrived at by both the customer and the DK. In the customer's

case, SA Doe was influenced by wishful thinking. His shipmate had told him he could draw special pay; the DK agreed. The DK assumed that SA Doe knew how much he could draw and that he knew the procedures for drawing the special pay.

You are responsible for giving customers all the facts to help them receive the service they need; you shouldn't assume that the customers already know that information. Likewise, customers shouldn't jump to conclusions before hearing all the facts. In this case, the customer was misled by incomplete information, and the contact point representative initially did nothing to provide the customer with the needed information.

### **CONTROLLING PERSONAL REACTIONS**

You may have adverse reactions to the customer. You may not like the person's appearance, speech, or attitude. These reactions can hinder you in providing the quality of service that the customer needs or deserves.

Attitude is probably the most common cause of adverse reactions. Maintaining a professional manner is difficult when the customer is cynical, overbearing, or a smart aleck. However you must overcome your personal reaction to the customer's attitude and redirect your energy to providing the needed service—isn't that what it is all about?

Customers who have an extreme dislike for the Navy often express that feeling through their attitude or approach. Their negative attitude or approach, in turn, evokes a negative reaction. The customer sometimes unconsciously displays a negative attitude or approach to produce results that will justify the poor opinion the customer has of the Navy. If the customer receives poor service because of the negative attitude or approach, then a negative opinion is justified.

You will probably remember a customer who gave you a rough time on a previous visit, and that memory may affect your response when you serve that customer again. Your idea of helping may then be to help the so-and-so over the side. You may see that as solving your problem, but it would not contribute very much to the customer's well-being.

Not all personal reactions are violent; they may be mild reactions caused by unconcern or lack of interest. However, these reactions can be just as deadly to a customer's satisfaction. For example, everyone possesses a feeling of self-worth. If the contact point representative denies this self-worth by showing a lack of concern or interest, the customer may show the same lack of concern or interest toward the Navy and its representatives as a defense.



You should be careful not to reflect negative attitudes through your behavior toward the customer. The following are some examples of such behavior:

- You may reflect your attitude toward a specific rating by your lack of interest in a problem of a member of the rating.
- You may reflect your view of yourself as intellectually or educationally superior in the way you talk down to the customer.
- You may reflect your aversion to touching by placing a pen on the counter rather than handing it directly to the person. (Have you ever wiped your hand on your trouser leg after shaking hands with someone?)

## STEREOTYPING

Stereotyping is forming a standardized, oversimplified mental picture of members of a group. We attribute fixed or general traits to all members of that group—disregarding individual, distinguishing qualities

or traits. Stereotypes can be based on traits such as sex, race, religion, nationality, length of hair, or even dress. We form mental pictures of people, things, and events based on the traits of that group to which they belong.

Stereotyping eliminates the need for us to know a person as an individual. It allows us to conveniently place a person in a group. Based on the traits we attribute to that group, we then believe we know all about that person. Placing the person in a group implies that the person has the same characteristics as everyone else in that group or category. That in itself is bad enough, but placing the person in a category you regard as inferior is even more offensive.

Don't confuse stereotyping with the practice of using personality and physical characteristics as memory aids. Many people rely on these to recall facts about individuals (name, occupation, etc.).

The following illustration points out the difference between a mental picture that is a valid aid to communication and one that is an unwarranted stereotype. Mental pictures are important because they are a quick way of conveying messages, but you must be sure they really fit the individual before you apply them.

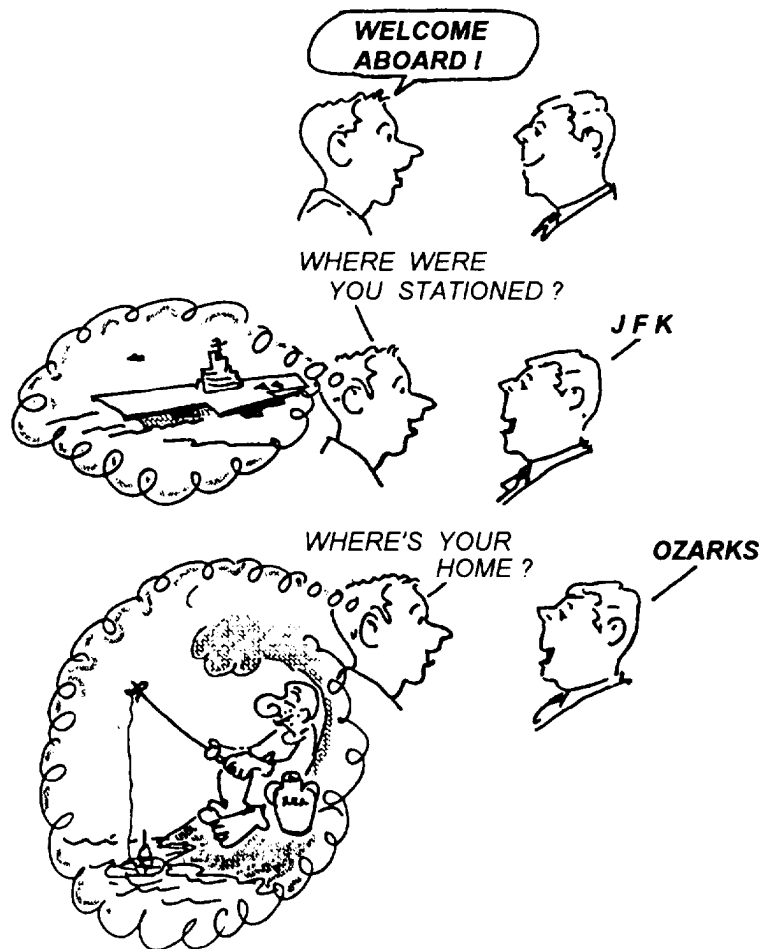



## FAILING TO COMMUNICATE

Communication requires more than just talking. One person cannot communicate. Communication involves a sender and a receiver and a message understood by both. The sender must be able to select words or visual signals that accurately convey the desired meaning and can be understood by the receiver.

All responsibility does not rest on the sender; the receiver must hear what is being said. When interference (lack of understanding or distractions) garbles the message, the receiver should ask the sender to repeat or explain the message. Misunderstanding information may be worse than receiving no information since it can result in disappointment, frustration, missed opportunity, or improper action by the receiver.

Sometimes it seems that you can almost see the earplugs in a customer's ears. What you are saying is not getting through. You may be tempted to shrug the incident off by saying, "I did my part. It's not my fault if the customer wouldn't listen." Are you sure that you did your part? After all, the customer came to you for information or advice but didn't receive it. Any one of several causes could have interfered with your message:

- The customer was vague about the particulars of the problem.
- You communicated with jargon, unfamiliar terms, or slang.
- You didn't make your explanation as thorough as you should have.
- You communicated or inferred that the customer or problem wasn't important.
- The customer had other problems.
- The customer felt rushed.
- The customer lacked confidence in your ability to provide the requested service.
- You failed to make sure that the customer understood.

Several types of language barriers can interfere with effective communications. Cultural differences, physical problems, language that reflects bigotry or prejudice, speech habits, and confusing terminology all can create a barrier to communication. However, the first two barriers—cultural differences and physical problems—are the most difficult for the speaker to

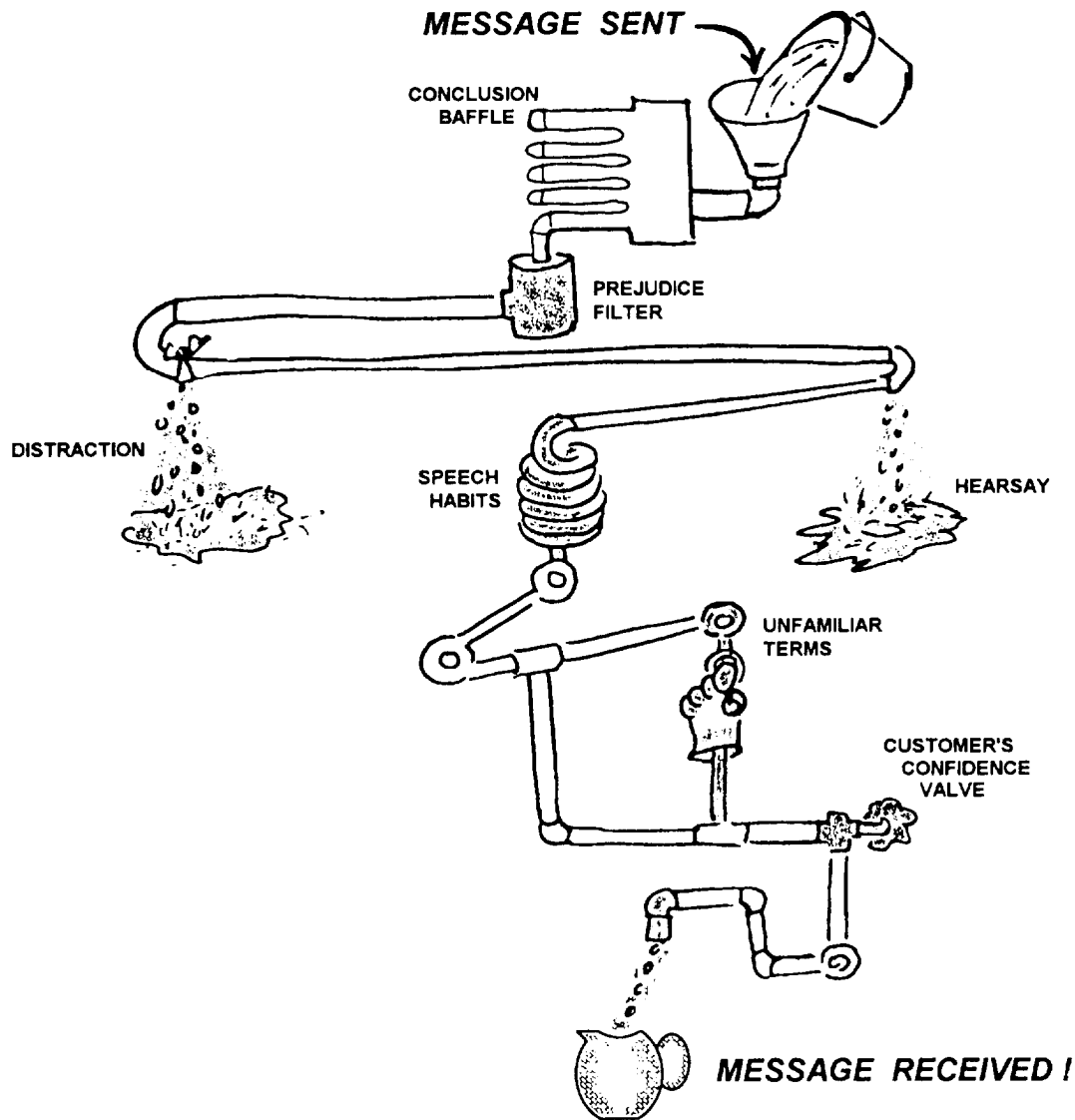

overcome. You, the customer, or both you and the customer may cause the barrier.

### Overcoming Cultural Differences

Persons for whom English is a second language often have difficulty with pronunciation and sentence structure. English is considered one of the most difficult languages to learn. Words that sound alike have completely different spellings and meanings, and words with similar spellings are pronounced differently. You cannot change the language, but you can overcome the barrier.

First you must listen with CARE and be sure that you know the nature of the need or problem; show an honest concern for what is being said. Then, carefully

phrase your questions, using relatively simple words; ask only one thing at a time. By first determining the nature of the problem, you will be able ask questions to gain additional information.

The customer who has difficulty speaking English also may have trouble understanding it. When the customer has difficulty understanding, speak more distinctly and more slowly. Watch the person's facial expressions for signs of misunderstanding.

### Overcoming Physical Problems

Speech impediments, such as stuttering or lisping, also cause misunderstanding. We did not list speech problems in our discussion of causes for adverse reactions. However, in some instances they may cause

a negative reaction. You may react negatively to the person who has difficulty speaking, and that person may react negatively to your inability to communicate with him or her.

The person with a speech problem is frequently sensitive about that problem and will resent any exaggerated manner of speaking on your part to overcome it. To overcome this barrier, maintain a positive attitude and concentrate on understanding the speaker's words rather than the speaker's choice of words.

### **Avoiding Language That Reflects Prejudice and Bigotry**

A major roadblock to effective communication is the use of words that reflect prejudice and bigotry. Such words show derision and deny the equality of another person. They give those who use them a false sense of superiority. They also reflect the personal characteristics of the speaker.

Prejudice and bigotry and the use of words that reflect those characteristics stem from fear, ignorance, and superstitions. Any term that shows derision could be included in this category, including commonly used terms such as *snipe* and *deck ape*.

People use words of prejudice and bigotry as a judging device—to size people up and to evaluate their traits. Using such terms relieves them of the need to know the person. The fallacy of this practice is that their actions reflect their attitudes and alienate the very person they are trying to help.

Everyone has prejudices of some kind. They are a part of our emotional character and the preconceived opinions we have of a person based on insufficient evidence. However, prejudices are directly opposed to our constitutional concept of justice—that a person is presumed innocent until judged guilty.

Rooting out prejudice takes time and effort, but the results are well worth it. In the meantime, make a constant, conscious effort not to use words that create resentment and anger.

### **Improving Speech Habits**

Some speech habits, such as slurred pronunciation, running words together, speaking too fast, exaggerated drawl or brogue, and profanity, interfere with understanding.

When a customer with one of these speech defects comes to you for service, concentrate on WHAT is being said—not HOW it is said. That will keep the distraction to a minimum.

The speech of the contact point representative may create a language barrier as well as that of the customer. Therefore, you should analyze your own speech pattern to determine whether you need to improve your manner of speaking. It's possible that you may have one or more of the habits discussed here.

Normally, we don't listen to our own speech, but you can get a reasonably accurate sample of your speech habits by recording an informal conversation and then listening to it carefully. Disturbing speech habits are not too hard to change, but first you must be aware that you have them.

If you find that your speech creates a language barrier, make a conscious effort either to eliminate the problem or to compensate for it. To compensate, speak slowly and give the listener time to follow and interpret what you are saying or to ask questions.

### **Avoiding Confusing Terminology**

The contact point representative sets the final barrier through the use of jargon, technical terms, and acronyms that confuse the customer. Using these terms and acronyms among coworkers who are familiar with them is okay. However, do not use them when speaking to the customer who is not familiar with them.

## **RESPONDING IN KIND**

Just as you respond to the attitudes of other people, you also respond to their moods. If the customer is in a friendly mood, you are more likely to be friendly. If the customer is in an angry mood, you may become cautious and defensive. If the customer is anxious or worried, your response may be vague and noncommittal. If the customer displays an impersonal attitude, you may do the same. In these situations, you have permitted the customer to set the mood for your contact. Instead of taking the initiative, you have responded in kind.

As a contact point representative, you usually behave in an impersonal, detached manner upon your first contact with a customer. You behave in this manner for fear that the person will reject your move by showing no response or by responding negatively. By first determining the customer's mood, you feel you haven't wasted friendliness or good humor on someone not worthy of it. However, the best tactic is to reverse the situation. Instead of waiting to detect the customer's mood, *you* speak up first. By recognizing the customer's presence in a friendly, positive manner, you may influence the *customer's* mood.

Showing friendliness is very much like having a secret power over the behavior of the customer. If the

customer rejects your offer of friendliness, it is the customer's loss—not yours. Friendliness is not a commodity that will experience extinction, so share it freely.

Hostility and anxiety reduce the customer's ability to see a problem fully, to express it correctly, and to accept the solution objectively. If you respond in kind, you reduce your ability to deal with the problem.

When the customer is emotionally upset, you must deal with two problems—the emotion and the need that aroused the emotion. Nothing can be gained by responding in kind to the customer's mood. In fact, such a response will probably make matters worse. Instead, try to calm the customer by being calm yourself. Show by your actions that you are ready, willing, and able to handle the problem.

### **GIVING THE AMIABLE RUNAROUND**

The emphasis on being friendly to the customer is a means to an end; not an end in itself. Your purpose in manning the contact point is to provide a service. You do not have a choice of providing either the friendly atmosphere or the service—you must provide both.

A friendly, helpful atmosphere at the contact point puts the customer at ease. A customer that is at ease can relate the problem more accurately; that, in turn, enables you to take constructive action to correct the problem. However, some contact point representatives think their job is to keep customers smiling and get rid of them; that is, to give them the amiable runaround. True, the customer goes away happy; but at some later time, that customer returns in a not-so-happy mood because the problem was not resolved.

A considerable amount of time and effort is required to deal with some problems or needs. In such instances, some contact point representatives try to make their job easier by convincing the customer that no action is needed in their particular case. This response denies service to the customer. If a customer requests service to which he or she is entitled, you have the responsibility to provide it. "It's all taken care of," tells the customer that you have taken all necessary action. That is a good response if you have truly taken that action; if not, you have performed a disservice—not a service.

### **PROMISING THE CUSTOMER ANYTHING**

You have probably met a contact point representative who agreed with every statement you made, sympathized with you, promised everything you wanted, but DID NOTHING. This type of service is

similar to the amiable runaround. It is a method used to "keep 'em smiling."

This type of service sometimes develops as the result of a "short-timer" attitude. In other words, some people who know they will soon transfer or retire become lax in performing their duties. They say to themselves: Sure, I'll promise you whatever you want to get rid of you; after all, I'll be long gone when you return to find out why nothing has been done. Promising anything may leave the customer temporarily satisfied, but you have only postponed, and possibly complicated, the problem.

Many times customers hear only what they want to hear. That causes them to hope or expect for results based on rumor, misunderstanding, or misinterpretation of fact. The way a customer asks a question usually tells you what the customer wants to hear. You have three choices in the way you answer customer's questions:

1. You can give the answer the customer wants to hear, although you know it is not completely accurate. That almost certainly guarantees disappointment to the customer later.

2. You can make vague statements and let the customer interpret them as he or she likes. That lets you off the hook because you really didn't give the customer wrong information.

3. You can give the customer the CORRECT information or interpretation. That may cause some grumbling, but the customer will not be depending upon hopeless expectations.

Offering anything less than the best information is unfair to the customer. A half-truth may be just as misleading and damaging as an outright lie. Future plans may be based on your "bum dope"; the morale, as well as the finances, of the customer could suffer because of it.

The friendly attitude of a contact point representative who gives this type of service is simply a cover-up for an attitude of unconcern.

### **OVERSTEPPING YOUR BOUNDS**

When providing service to customers, you may be tempted to overstep your bounds. That is, you may sometimes feel like criticizing coworkers, policies, procedures, or instructions or joining in customer complaints. Resisting these temptations, however, can often lead to positive results.

## **Criticizing Coworkers**

Heavy work loads, inexperienced personnel, unfamiliar situations, and carelessness all lead to the likelihood of errors, which you must correct at some later date. If you seldom make a mistake, you may have a problem understanding why other personnel frequently do.

When you find a mistake while helping a customer, resist the temptation to “sound off” to the customer about the person who made the mistake. Such action gains nothing; correcting the error requires the same amount of effort whether or not you express your feelings. Instead, simply explain when and where the mistake was made, and then take steps to correct it. Most customers will forget their annoyance once they understand the problem and know that it will be corrected.

## **Criticizing Policies, Procedures, and Instructions**

If you disagree with official Navy policy, command policy, or divisional procedures or instructions, resist the temptation to criticize them to your customers. You don't have to agree with all of them, but you must follow them. Discussing them among your coworkers may lead to a better understanding of policy. It may also result in positive changes, such as a more efficient procedure or a better flow of information, that improve your ability to help the customer. Discussing them with your customer, however, serves no helpful purpose.

When a customer's request is denied because of current policy or regulations, frustration or resentment is a natural reaction. If you express your disapproval or criticism of this policy or regulation, it increases the customer's feeling of resentment or frustration. You have not helped-you have only made it harder for the customer to accept the inevitable answer. However, you should explain when a policy is only temporary or when it is expected to change so that the customer knows the current governing instructions.

## **Encouraging Complaints**

Since you are a source of answers to problems, customers may sometimes bring you a problem that you are experiencing yourself. The SN's comment, “The division officer doesn't like me,” in Case Number 4 opened the door for the PN to offer his shoulder for the SN to cry on. The PN could have joined the SN in a duet of self-pity and condemnation, but what would that have

accomplished? Rather, the PN determined the real cause and took positive steps to correct it.

You may have some customers whose problems are only imaginary. They want to complain about their petty officers, division officer, duty assignments, working conditions, or the hole in their socks. In these situations, you must listen, but remain objective. Once again consider Case Number 4. PN Doe listened objectively to SN Frost's complaints about his division officer. Then she checked the Page 4 of SN Frost's personnel record and found he had not completed his PARs. After a phone call to Frost's division officer, PN Doe was able to show the customer the specific causes of the problem. Her action to correct those causes did much to improve the customer's attitude and discourage complaints. Had she encouraged the customer's complaints by sympathizing with him or agreeing with his feeling of unfair treatment, she would have reinforced the customer's negative attitude.

What should you do when faced with a similar situation? You should try to improve the customer's attitude. If, like the SN, a customer has an attitude that he or she is being picked on, try to show the customer the specific causes of the problem. Then, take action to correct those causes. Your actions will do much to improve the customer's attitude.

## **SHOWING APATHY**

You show apathy by acting as though a customer is too much of a bother; apathy is discouraging to a customer. You can reflect apathy with a shrug of the shoulders or words that imply who cares? What's your hurry? or, What's the difference? Such responses give the customer little hope in getting help with a problem.

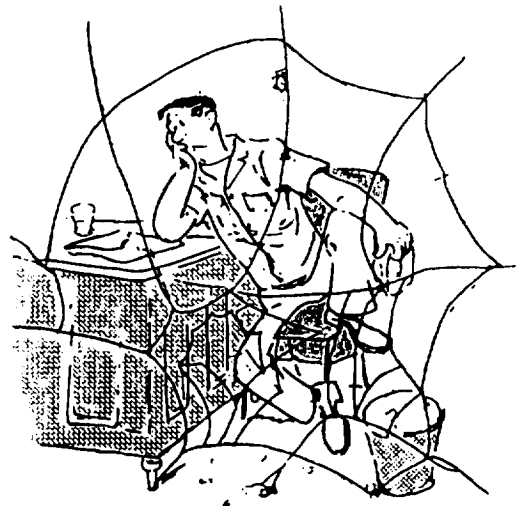

Keep in mind that, no matter how simple or unimportant you consider a request, the customer depends upon you to provide a service. Answering a question or looking up information may require a little effort on your part, but the extra effort is a mark of good service. As stated earlier in this manual, customers usually have only one place they can go for a particular service.

Apathy is the result of a negative attitude toward life in general or toward your job or duty assignment. Apathy is difficult to overcome because apathetic people have already given up hope for improvement in their life or their job. People develop apathy for various reasons:

- They see no purpose in their job.
- They see no benefit in providing customer service.
- They have been doing the same job too long.
- They see no possibility for advancement or increased responsibility.
- They are not challenged by responsibility.

- They have no plans for continuing their Navy career, so they have decided to perform at the sheer minimum.

Apathetic contact representatives who do nothing to change their attitude are shortchanging themselves as well as the customer and the Navy.

### **MAKING THE CUSTOMER WAIT**

The customer often hears, "What's your hurry? You're not going anywhere!" The implication is that time is a factor only for the contact point representative—never for the customer. Ordinarily, the customer should receive help without having to wait. However, a customer who has to wait because you are snowed under will usually understand.

Options are available to reduce waiting time; you can set up appointments or set up special service hours, just to mention two. Use any system for routine service that speeds the process, but make sure it allows for emergencies. Never use a system to limit service.

### **BREAKING ROUTINES**

It is Thursday afternoon, and HM Doe is busily engaged in putting the finishing touches on a spotless



sick bay. He is just finishing the deck when in walks MM Boate. He is tightly gripping his left wrist while blood wells from a cut and drips onto the floor.

“What’s the idea? Can’t you see the ‘Secured’ sign on the door,” demands HM Doe?

“What do you mean, secured? I cut my hand!”

“Sorry about that, but I haven’t got time now to treat it—I have to finish up field day. Come back in about 30 minutes, and quite dripping blood on my clean deck!”

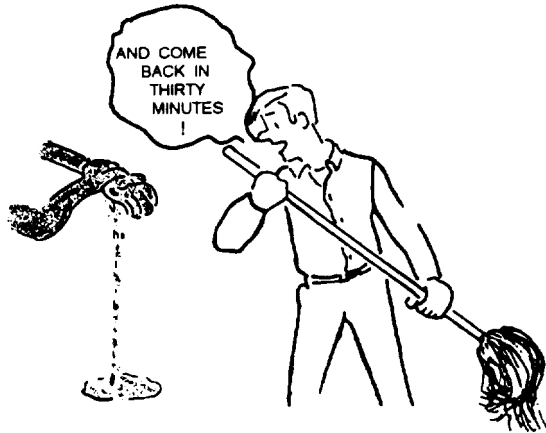

Does this seem farfetched? Not at all; it is an extreme example, but it actually happened.

Routines or procedures help us provide more efficient customer service by enabling us to do jobs easier, faster, and more accurately. However, if following a routine becomes more important than providing service, you need to take a good, hard look at your job priorities. Routines are intended to improve service, not to hinder it.

### **CUSTOMER SERVICE**

Thus far, we have focused our discussion on attitude. Although attitude is important when dealing with others, good attitude alone is not enough. The customer comes to the contact point for service—not camaraderie.

What would be your reaction in the following situation? You have gone to the dental clinic with a toothache. The DT meets you at the door with a smile, shakes your hand, shows you to a chair, and offers you a cup of coffee. You say, “Thanks just the same, but this tooth is driving me up the wall. Can you take care of it?”

The DT replies, “Oh, I don’t know anything about teeth—but I’m friendly.”

This situation is ridiculous. You know that carrying out your responsibility at a contact point requires professional competence. Professional competence includes knowing what you can do, how to do it, and when to do it.

### **KNOWING MEMBERS’ RIGHTS AND PRIVILEGES**

All Navy members have certain rights and privileges by law. You have the responsibility as a contact point representative to know what these rights and privileges are and to whom they apply.

Some customers choose not to take advantage of certain rights and privileges, while others may not be eligible for them; for example:

- You may have no dependents; therefore, you have no eligibility or need for dependents’ health care.
- You may choose not to take advantage of available educational opportunities.
- You have too many years of service remaining to worry about the details of retirement.

Even though some customers will not use the rights and privileges they are eligible for, others will. You must be prepared to answer their questions regardless of whether they intend to take advantage of them or not.

Some contact representatives feel they are doing customers a favor by providing information about these rights and privileges. They think they may grant or withhold such information as they wish. That should not be the case, and it should never occur! The Navy provides these rights and privileges as incentives for enlistment and reenlistment and as a form of compensation. Withholding them for any reason except as provided by law undermines members’ morale and confidence in the Navy and defeats the purpose of providing them.

### **KNOWING REGULATIONS**

After the customer has explained a problem, you must then decide what you can do to solve it. You must have a thorough knowledge of pertinent regulations and directives if your decision is to be appropriate.

One thing common to all contact points is the volumes of regulations, manuals, and directives that set



forth the limits and procedures that govern your performance. You do not need to memorize their contents, but you should know what information each reference contains. Then when a question arises, you will know which source to turn to for the correct answer. In fact, rather than trying to learn all the answers, you should concentrate on learning the proper sources for finding the answers. You will soon learn the answers to many routine questions, and you will find that you don't have to look them up each time. However, if you rely on memory for answers to infrequent problems, you run the risk of error because of obsolete information.

Many sources provide information on the rights and privileges of Navy members. They include official and unofficial Navy publications and commercial periodicals as described below:

- Official publications include manuals, instructions, and notices; they are used by all levels of the Navy.
- Unofficial publications reach a larger audience than do the official. They include *All Hands*, systems commands and bureau newsletters, and ship and station newspapers.
- Commercial periodicals, such as *Navy Times*, also have wide circulation among Navy members and dependents.

All of these references contain information about the Navy members' welfare: rotation and assignment, pay and allowances, advancement opportunities, health care, and exchange and commissary benefits. You cannot cite unofficial and commercial publications as authority. However, since they usually contain information and reasons for changes or new programs, which are not included in official directives, you can use them to get background information. Background information can help you do a better job of explaining the directives to the customer. Often, unofficial and commercial publications also provide advance information that alerts you to forthcoming changes or new programs.

The contact point representative must afford the customers rights and privileges impartially, but keeping in mind that all customers don't have the same rights and privileges. At some point, you will have the unpleasant task of explaining why a disappointed customer is not eligible for a particular program or service. The following are examples of such situations:

- Two members are reenlisting. They are both completing their first 4-year enlistment, and both are at paygrade E-5. One is entitled to a selective reenlistment bonus (SRB) and the other is not.

- An MS2 and SH2 both reported aboard ship in January 1988. Therefore, the projected rotation date to shore duty was July 1991 for the MS2 and July 1992 for the SH2.

The underlying reason for setting limits and qualifications is to ensure the Navy has enough capable personnel to perform the jobs to meet the needs of the service. If that were not a consideration, a member who attends college could at the end of a 4-year enlistment be handed a discharge and a diploma. That would provide the member with the maximum educational benefits, but it would not provide the Navy much in the way of operational manpower. Our programs must do both—maintain enough personnel to carry out assigned missions while offering the greatest possible opportunities to Navy members.

You have two responsibilities when dealing with a customer who is not eligible for some right or privilege. The first, of course, is to be certain of your facts so that you do not deny an opportunity to which the member is entitled. The second is to explain the reasons the customer is not eligible so that your motives will not be questioned. A customer must have no doubt that the denial was based on regulations, not on your opinion or favoritism.

## KNOWING YOUR LIMITATIONS

Just as important as knowing what you CAN and SHOULD do is knowing what you CANNOT do.

Although benefits are to be afforded impartially to all eligible members, they may be omitted at some commands because of any one or a combination of the following:

- Directives
- The size or location of your ship or station
- A lack of qualified personnel

The amount of services normally available differs between a small ship and a large ship or between a ship and ashore station. Thus, the limitations may be inherent to the command. The following are some examples:

- A PO2 transferring from ship to shore is entitled to shipment of personal effects, but ship's personnel can't make the arrangements. That must be done ashore.

- A member aboard a destroyer has every right to expect competent service aboard ship on matters relating to pay. Not so, for a member aboard a minesweeper—this member must depend upon the facilities ashore or the facilities of another ship.

- A ship's store aboard a carrier carries as many products as some exchanges ashore. The ship's store on a destroyer must limit itself to little more than necessities.

- A member stationed ashore may take advantage of the tuition aid program or VA benefits and attend college during off-duty hours. The member afloat seldom has an educational opportunity other than correspondence or extension courses.

- Medical and dental facilities in the Navy are the best available. However, the services that are provided by the Naval Hospital, Bethesda, Naval Medical Command National Capital Region, are far greater than those aboard ship. Shipboard personnel are no less dedicated or qualified. The limitation results from lack of facilities and personnel. Even the services aboard ships vary with their size and mission and the personnel and facilities available.

- Legal assistance is a very valuable service. However, legal assistance aboard a ship without a lawyer is limited to referring the member to legal assistance officers ashore.

- The size of the enlisted dining facility afloat or ashore is usually high in quality and the choice of items offered. Here again, a lack of facilities and personnel could impose limitations.

Unexpected loss of personnel, equipment failure, or an unusually heavy work load may impose temporary limitations on the operations of your contact point. You must then work around those limitations to ensure you still provide the best possible service.

## **KNOWING ALTERNATIVES**

Few of our decisions in life are based on a "do this or do nothing" type of choice. We usually have alternatives from which to choose. The following are examples of some choices Navy members might make:

- Members who have completed their enlistment have several alternatives: extend, reenlist, or separate.

- An SK in charge of a ship's store can choose whether to suggest a substitute for an item that is temporarily out of stock or to simply say, "We don't have it."

- Members who score too low on tests to qualify for the rating of their choice may choose to retake the tests to try to improve their scores or they may choose to strike for a related rating that does not require the higher scores.

- As in Case Number 7, a contact point representative may know of a service provided by another contact point that could help a customer. The contact point representative can choose to help the customer by sharing that information or to let the customer find out through other means.

As a contact point representative, you should not try to make decisions for the customer, but you should explain options. Even though customers may not always make the wisest choice, they should have the options explained to them.

## **CUSTOMER ASSISTANCE**

The mechanics of your job are normally of no concern to the customer unless they have a direct bearing on the customer's problem. However, they sometimes might be the reason for action or a lack of action contrary to the customer's wishes. In that case, some explanation will increase the customer's confidence in your ability and knowledge.

On the other hand, needless discussion about how hard your job is or how much effort you are exerting to get the job done would be counterproductive. The customer is not likely to feel an overwhelming gratitude for a job done under protest.

You are never justified in ignoring a customer; to be ignored is discouraging to a customer. There are times when you can't drop what you are doing; however, you can acknowledge the customer's presence. If you are busy with a customer, a look and a nod will acknowledge the second customer's presence. However, your actions to put the second customer at ease should not cause the first customer to feel rushed. If you have other brief work that you want to finish, one sentence of explanation is sufficient. Most people don't mind a

reasonable wait when they know that you are aware of their presence, but they should not have to beat on the counter to get your attention.



Customer service at large activities is frequently a problem for customers. A dispensary or sick bay provides most services in one room. On the other hand, a hospital provides services in many rooms and usually on several floors. The customer can get the feeling of playing hide-and-seek at any command, large or small. When referring the customer to another location (desk, office, or building), be courteous and be sure to give good directions.

## ANSWERING QUESTIONS

Answering questions at a contact point requires a sizable amount of patience. That is especially true when you must answer the same questions over and over.

Some of the questions are simple, others are hard, and some are ridiculous; but all deserve the courtesy of an answer—even those that seem ridiculous. Answering those types of questions may help customers realize they simply used the wrong choice of words or that they needed more information. Customers can then rephrase the questions to clarify the type of information needed.

The young PO3 that asks, “Hey, can I ship my furniture now?” really means something quite different. Sure, the furniture can be shipped now or anytime. The

PO3 is really asking, “Am I now entitled to ship my furniture at government expense?”

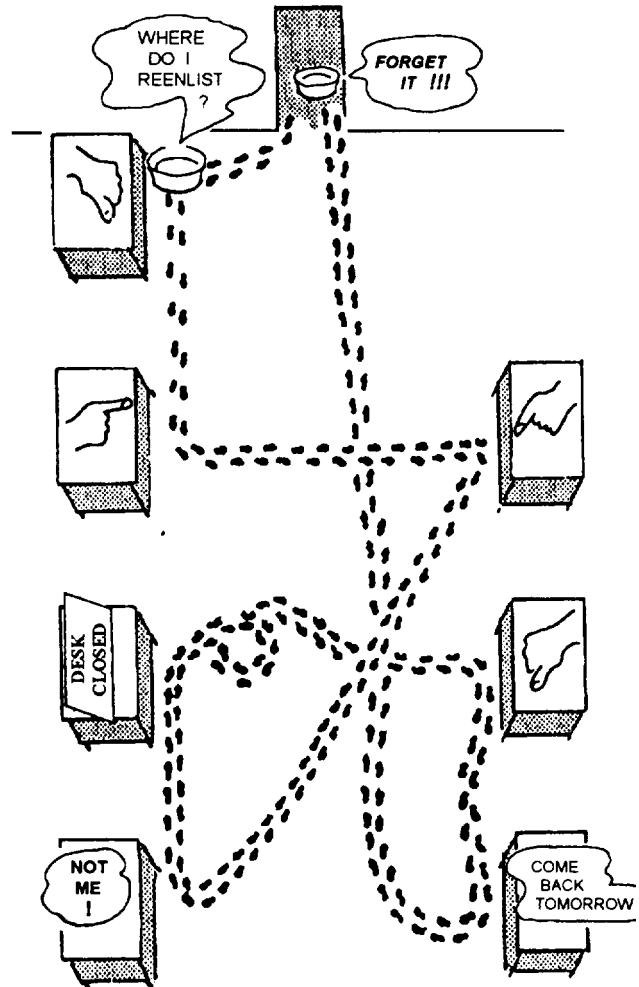

Any change in entitlement, such as the one entitling PO3s with over 2 years' service to ship personal effects at government expense, brings on the questions. You should anticipate and become familiar with the changes so that you can provide accurate and timely answers.

You, being the specialist in your field, must respect the customers' lack of expertise. The lack of expertise is the reason for the questions. Don't belittle the customer's lack of knowledge. The customer is most likely as knowledgeable in his rating area as you are in yours.

## MEETING UNEXPRESSED NEEDS

If you have the impression that you are to act only when the customer pushes a button, then you have the wrong impression. True, you perform much of your

work in response to customer's expressed needs; but at times you should take the initiative.

The PO3 mentioned in the above section had heard about the new entitlement for shipping household goods, but had he heard about the other portions of the instruction: dependents' travel pay and dislocation allowance.

Each command makes a constant effort to make sure that everyone "gets the word" through the use of bulletin boards, notes in the plan of the day, and announcements at quarters. You can improve this effort by volunteering information that the customer can use but may not know to ask for.

Customers may get information from many sources, but that information may not be correct. During your conversations with these customers, you can usually tell from their questions or comments that they have received incorrect information. When that happens, be sure to tell them the correct information.

### **GIVING SIMPLE EXPLANATIONS**

Let's look at a story of a junior officer who was assigned to draft a letter for the captain's signature. After much work, the junior officer had a draft ready to go topside for approval. The next day, the officer was astounded when the captain returned the draft with the word "KISS" printed in bold, red letters across the first page. Did that mean the captain liked it? The officer pondered the meaning of the word for awhile and then began to ask others in the office if they knew what it meant. An old-timer finally explained, "That is the 'old man's' way of telling you to do it over. It means, Keep it simple, stupid!"

That expression may be rather crude, but it is good advice. Anytime you explain something to someone, your explanation must be understandable. You should not place the customer in the embarrassing position of having to ask for an explanation of unfamiliar terms. If you use a term in a way that implies the customer should know what it means, there will be an even greater reluctance to ask for clarification.

Watch for signs that indicate the customer does not understand your instruction or explanation. When you see those signs, back up and rephrase your explanation or instruction.

### **USING TELEPHONE COURTESY**

Few inventions can equal the telephone for efficient labor-saving and time-saving convenience. However,

because we use it carelessly, we don't always obtain maximum benefit.

Good telephone communications require more thought than face-to-face communications. You don't think so? Consider a sportsman who is bragging about the success of his recent fishing trip. Upon meeting a friend, he explains by spreading his arms and saying, "I caught one this big!" When talking face to face, our gestures and facial expressions help to convey the intended message of our words. However, if the sportsman makes the same statement while talking on the telephone, his words have little meaning.

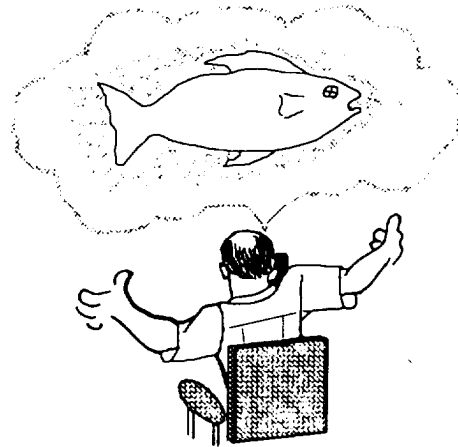

When customers come to your contact point during a time when you are busy helping others, they can see the reason for your delay in serving them. However, when they call on the phone, they cannot see the reason for your delay in answering. If the phone rings several times before you answer it or if you answer and immediately say, "Hold on," they may think you are telling sea stories instead of tending to business.

Suppose you have almost completed a financial report; you have only a few more figures to add, and then you will know if it's going to balance. The phone rings and you ignore it. It rings a second and third time, and you begin to mutter obscenities about the aggravation.

In this scenario, the phone rang at an inconvenient time; but the caller had no way of knowing that. You might as well have answered it on the first ring since it interrupted your concentration anyway. Besides, answering immediately after the first ring saves time for both you and the caller. To swear at the phone for ringing

is as logical as throwing a hammer after having smashed your thumb with it.

At times when you answer the phone, you may be too busy to help the customer. When that happens, ask if you can call back rather than keep the customer waiting on the phone for an extended time. A minute spent waiting on the phone seems twice as long as a minute spent waiting at the contact point.

When you answer the phone, first identify your office or activity and then identify yourself. As in case number 7, some contact point representatives answer the phone correctly, but they speak so fast the customer can't understand what is said. When you speak too fast, you may then have to listen to a long, involved story before you can refer the customer to the correct number.

Just as facial expressions and gestures help us express a thought, they also help us convey feelings and attitudes. The words and the voice you use over the phone must do the entire job. Tact is, therefore, vitally important.

Telephone use presents an added problem for the person who has difficulty with the English language or who has a speech defect. The same consideration should be shown to such a person over the phone as when talking face to face.

Perhaps the guiding principle when using the telephone should be to remember that you are not talking to a telephone, but to a person.

### **COMMUNICATING CLEARLY**

There is a story of a New York plumber who wrote the Bureau of Standards at Washington that he had found hydrochloric acid fine for cleaning drains. He then asked if it was harmless. Washington replied, "The efficacy of hydrochloric acid is indisputable, but the chlorine residue is incompatible with metallic permanence."

The plumber wrote back that he was glad the Bureau agreed with him. The Bureau replied with a note of alarm, "We cannot assume responsibility for the production of toxic and noxious residues with hydrochloric acid, and suggest that you use an alternate procedure."

The plumber was happy to learn that the Bureau still agreed with him.

Whereupon Washington exploded, "Don't use hydrochloric acid; it will definitely eat the pipes!"

A federal law or a Navy policy about a specific subject is issued in the form of an official publication.

The publication uses specific language to show exactly what the law or Navy policy is intended to permit or prevent. It addresses the reader who is familiar with that subject, so a person having a limited knowledge or experience in that subject may misunderstand the information given. Your job as a contact representative may require that you explain information contained in these publications. Your explanations should leave no doubt in the customer's mind about the intent of the information.

The advantage you will have over the Bureau of Standards, as described in the above story, is face-to-face communications. You can watch for gestures and facial expressions that tell you if the customer understands your explanation. If needed, you can then rephrase your explanation.

### **FILLING OUT FORMS**

Sometimes the supply of forms a Navy member must fill out seems endless. You are familiar with the forms used at your contact point as well as their purpose and how to prepare them. Therefore, you may easily forget how frustrating they can be to the customer.

The Navy has forms for every purpose-and good reasons for them. A form provides information required for certain actions. You may view the forms used at your contact point as self-explanatory, but the customer may view them as perplexing. That is particularly true for a person who has been in the Navy only a relatively short time.

Filling out a form can be doubly frustrating if after completing it, the customer receives it back with the words, "Do it over. You filled it out wrong." To avoid having to ask someone to fill out a form a second time, take a little extra time with that customer. Before the customer ever begins to fill out the form, explain any items that might be misunderstood. The extra effort will save you time because the customer is more likely to complete the form correctly.

### **EXPLAINING FUTURE STEPS**

Quite often when the customer comes to you for help or advice, you will only be able to provide partial assistance at that time; you will have to take additional action later. You need to explain to the customer what that action will be. Be sure that both you and the customer agree on and understand who will initiate the future action. The customer should have no doubts about WHAT must be done, WHEN it should be done, and WHO is to get it started. You should have no doubts

about the customer's understanding of the actions to be taken. If several actions are involved or if these actions cover an extended period, you might want to repeat the basic actions to be taken just before the customer leaves.

### **GIVING FURTHER ASSISTANCE**

Frequently you can help customers get additional help by referring them to another source of information at another contact point. When you refer a customer to another contact point, make sure the customer knows where to go and what to ask for. Be sure to make the referral in such a way that you do not appear to be giving the customer the runaround.

### **EXPLAINING RESULTS OF ACTIONS**

PO Frost purchases a home and is told that he might be allowed to make the mortgage payments through an allotment. After checking with a DK in the disbursing office, the PO decides that the allotment is the best way to make the payments. Since he has already made the August mortgage payment, PO Frost starts the allotment effective in September. He expects the allotment to cover the rest of the mortgage payments beginning with the September payment. What PO FROST doesn't understand is that he will have to make another payment before the allotment begins to be applied to the payments. The DK in the disbursing office could have prevented this misunderstanding. The DK needed only to state, "The amount of the payment will be deducted from your pay in September, but the first check will not be mailed until 1 October." That is just one example of the need to explain fully the results of action being taken.

### **MAKING PROMISES**

Earlier we spoke about the practice of promising action simply to pacify and get rid of the customer. "That is not the only type of promise that leads to ill feelings. Some contact representatives actually promise service or action over which they have no control. In Case Number 5, the disbursing officer might have promised PO Seaman that his pay would be straightened out by a certain date. However, since the disbursing officer had no control over when the pay order would be received from the previous command, he made no promise.

As a contact representative, you might have a customer who is filling out the duty preference card for future assignments. That member might want your assurance that the next transfer will be to a duty of choice. However, you can't legitimately make that

promise because the future assignment is out of your control.

**Don't promise performance that is above your capacity to deliver; and don't be too optimistic about your capacity to deliver—unforeseen events may interfere.** If you have any doubt that you might be unable to keep a promise, explain that possibility to the customer. Then assure the customer that you will do your best, but don't promise to deliver.

### **RECORDKEEPING**

Many of the actions at a contact point involve records; these records may consist of various forms and records of actions. Many of those records are required by official directives. Some examples areas follows:

- Pages of the service record
- Personnel advancement requirements
- Entries on the leave and earning statement (LES)
- Forms required for starting or stopping allotments
- Postal money order forms
- Forms required for transportation of personal effects
- Performance evaluation forms
- Applications for Navy correspondence courses

If you are performing your duties satisfactorily, you will know how to fill out the forms and records of action appropriate to the services you provide—or how to help the customer fill them out. You will know the required number of copies and what their distribution should be.

In processing records, all that you need to do to give the customer satisfactory service is to perform your regular duties correctly. Strive to keep accurate records. Making a mistake can cause trouble for yourself as well as for others who must process your paperwork. However, mistakes are likely to result in much more trouble for the customer than for you.

### **KEEPING RECOMMENDED RECORDS**

You keep some required records as governed by official directives. However, you keep some required records that are not governed by written directives. The following are examples of some records you must keep even though you have no written directives:

- Educational counseling record—You make an entry in this record each time the customer receives counseling or takes any new action, such as enrolling in a course or taking a test.
- A personal reference—You keep this record of names, offices, and phone numbers for sources of information and assistance.
- Handwritten notations—You keep handwritten notations as a record of an interview with the customer and future actions to be taken.

### **MAKING PROPER DISPOSITION OF RECORDS**

Proper disposition of records is just as important as keeping clear, complete, and accurate records. No matter how good your records are, they are of no use if they aren't filed correctly.

Official directives or the instructions printed on the record often tell you what its disposition should be. Then your duty is merely to make sure you follow those instructions. Rarely does a good reason exist for losing an allotment request or failing to place personnel advancement requirements in a member's service record. Neither does a good reason exist for failing to

insert a service record page into a record folder or for making proper distribution of the copies.

Some records don't provide a distribution list; however, making the right distribution of the record is still important. The following are examples of how you should make some routine distributions when no list is provided:

- You should file a copy of correspondence pertaining to a Navy member in that member's service record as well as in the general file.
- When holding forms for future action, you should attach a note to them indicating what action is required and when.
- You should make notes in a tickler file or on a calendar to remind you when to take certain types of actions.

### **FOLLOWING STANDARD FILING PROCEDURES**

Always use standard Navy filing procedures. You may have a private filing system that works fine, but you are not the only person who uses the files. Others must also be able to locate items in the files.





## CHAPTER 4

# THE TEAM APPROACH

### LEARNING OBJECTIVES

*Upon completion of this chapter, you should be able to do the following:*

- *Discuss the team approach when handling customer needs.*
  - *Identify effective ways of improving the team's ability to provide quality service.*
  - *Discuss training techniques when relating to customer service.*
  - *Discuss and take personal inventory of the service you receive as a customer.*
- 

In the previous chapter, the emphasis was on how YOU should perform at the contact point to meet the customers' needs. However, most contact points consist of more than one person. Together these people work together as members of a team to perform the functions of the contact point. In this chapter, we will concentrate on how the members of the contact point team work together to meet the customers' needs.

### ACHIEVING TEAMWORK

Each member of a football team is an individual. Yet, if each member functions as an individual on the field, the results are easily predictable. Eleven quarterbacks would have a difficult time advancing the ball. Even one or two members acting individually would have a disruptive effect on the team's performance. Whining requires teamwork.

The team is not an entity in itself; it is a group of individuals. You may be a member of that group as a striker, a junior petty officer, a leading petty officer, or a supervisor. Being a member of a team does not deny you the chance to perform as an individual. Rather, it allows you to cooperate and act together with other team members toward a common goal. Thus, a team consists of individual members with varying personal traits—some positive, some negative. To achieve teamwork, you must emphasize the positive traits.

### EMPHASIZING POSITIVE TRAITS

Most team members have some undesirable traits, which they may or may not be aware of. No one would argue the value to both the person and the team of having

undesirable traits identified and corrected. However, emphasizing a person's undesirable traits usually antagonizes the person and accomplishes little. Rather, by emphasizing the person's desirable traits, you may find that the undesirable traits begin to disappear. Most people have a strong desire to be accepted by their peers, and they will adopt the behavior that leads to that acceptance.

### PROVIDING ENCOURAGEMENT

Yea-a-a-a team! The intent of a cheerleader's yell is to infuse spectators with enthusiasm that will give the team members the additional push they need to win. This attitude of encouragement is another important aspect of teamwork. Team members who encourage each other work well together.

### PROVIDING ADVICE AND ASSISTANCE

Providing advice and assistance is an important aspect of teamwork. You might be more proficient in a specific area of your rating because you have had more experience than other team members. When that is the case, offer to provide advice and assistance to those who need it.

Remember, you are not playing a game in which you win or lose—you are providing service. If you see a team member about to make a mistake that could have adverse results for the customer, act to correct it. However, make sure your action is tactful. The scenario might go like this: "John, I may be able to save you some time. This situation is similar to the one that I just experienced a few days ago, and we found that by. . ." Thus, you have acted tactfully to correct the problem by

sharing your experience, but you have not made your teammate feel inferior.

### PROVIDING A POSITIVE INFLUENCE

Each individual exerts some influence on all other members of the team. For example, the member who always has a “Good morning” for everyone influences the team to have a positive attitude. However, the member who always gripes and complains has the opposite effect.

Each member not only influences the mood of the team, but also its work habits. Work habits, in turn, influence the team’s effectiveness in providing service to the customer. The first of the following examples shows how a negative influence can affect teamwork; the second example shows how it can affect customer service:

- A new member reports for duty at your contact point, and you are the first person the member meets. After introductions, you feel it is your duty to give the new member some “survival training.” You begin by saying, “Senior Petty Officer Door is hard to work for, especially when she has it in for you. PO Brush won’t bother you; he’s so lazy it’s an effort for him just to breathe. SN Frost is an eager beaver, but he is handy to have around—you can con him into almost anything.” Giving these opinions places an unfair burden on the new member. Regardless of whether these statements were truth or opinion, they will have influenced the new member’s attitude toward the team.

- You are standing at the counter when a customer walks in, and you ask, “May I help you?” The customer then presents a problem that involves several actions. Since you are not sure how to proceed, you ask a coworker. The coworker only gives you a negative shake of the head and advice to “ask the chief.” That doesn’t help much, so you turn back to the customer, muttering to yourself, “The last time I asked the chief for help, he told me to look it up myself—he didn’t have time.” Then to the customer, you say, “Why don’t you tell the chief your problem; he’ll be able to take care of it, and he won’t get mad at you.” You have placed the customer in an uncomfortable position. Your attitude and negative remarks have influenced the customer to feel reluctant to talk with the chief. If the customer chooses not to talk with the chief, the customer will not receive the needed service.

### RECOGNIZING THE VALUE OF EACH JOB

Most contact points have many jobs to perform. Although team members must be able to perform all jobs

at the contact point, they usually perform only one job at a time. Although some jobs may seem less important than others, EACH job is EQUALLY important. Whether the job is receiving leave requests or preparing leave authorizations, team members must recognize the value of each job at the contact point.

To recognize the value of your job, you need to know its purpose in the overall mission of the contact point. Ask questions. Find out how the responsibilities of your job fit into the overall responsibilities of the contact point. You will then begin to understand the value of your job and how your performance contributes to team effort.

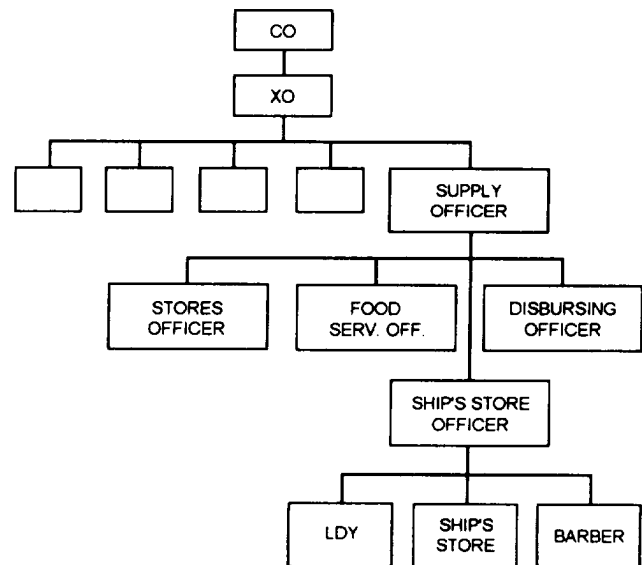

## **INCREASING YOUR KNOWLEDGE**

When considering the job of a contact point representative, we might agree with the old saying that a little knowledge is dangerous. *Dangerous* may be a bit strong, but personnel working at contact points do need to be experts in their own rating to contribute effectively to teamwork.

Your knowledge of other contact points can also be helpful to the customer, especially if customers must visit several contact points to meet their needs. For example, some activities may require a customer to report to different contact points to check in, checkout, reenlist, transfer, or effect separation. You need to know what services customers can receive at other contact points and know how to direct them to those points.

When the customer in case number 3 asked LPO Brush about shipping his personal effects, he was told to ask supply. LPO Brush should have told the customer, "The personal effects office on base makes all the arrangements for personnel moves. When we moor, you take copies of your orders and go talk to a contact point representative at that office. Most likely the representative will schedule you for an interview in which you will be asked specific questions about your personal effects. You may be asked about furniture weight, storage requirements, special handling requirements, and desired pack-out and delivery dates."

## **SETTING PRIORITIES**

We rarely have enough time, energy, or resources to do everything that we need to do or that we would like to do. To achieve teamwork, you must evaluate demands to ensure the most important ones receive the most attention. That will keep you from bogging down in details and routines that leave little time for the important tasks.

## **COMPROMISING**

It has been said that a wise man isn't as stubborn about anything as a fool is about everything. Not only are we unable to do everything we want to do, we often cannot do things our way. Contending with opposing points of view is just part of life—and of achieving teamwork.

Compromise may be seen as a dirty word because the idea of individualism gets mixed up with personal preference. Compromise is not defeat; it is recognizing that there might be a better way to do something and being mature enough to explore it.

## **ASKING FOR HELP**

In chapter 3, we discussed the importance of knowing your limitations. One such time is when the problem exceeds your knowledge or ability to handle it. That frequently happens since most contact points have a wide range of responsibilities and few members know all the answers. One of the main advantages of teamwork is that help is normally available when you need it. Taking advantage of that help prevents risking an error that could result in unnecessary hardship or inconvenience for the customer.

Whether to ask for advice or assistance or to refer the customer to someone else depends largely on the nature of the problem and the complexity of its solution. If the situation permits, you can often ask questions that will help you decide whether you should handle the problem yourself.

If your questions fail to gain enough information to solve the problem, don't expect the customer to know automatically where to go for help. Instead, provide the customer with that information yourself. If you are unsure of the contact point to which you should refer the customer, take the needed steps to find out.

Be courteous to all customers when trying to solve their problems. But be especially courteous to those who are relatively inexperienced and new to the Navy. For example, suppose you need to refer a customer to a contact point in the immediate area of your building. You might escort the customer to that contact point, introduce the customer, and explain the problem. However, when you make the referral, your manner should assure the customer that you are NOT "passing the buck," but that the other contact point can best provide the service.

The following scenario is a good example of how asking for help can result in teamwork to solve a problem:

The ship's crew had just completed an UNREP and was settling back into the underway routine. Mail call, one of the more pleasant aspects of UNREP, had been passed and everyone was eagerly catching up on the news from home. The personnel office was no different—the members were engrossed in their letters and occasionally sharing stories about what their loved ones had said or done.

PNSN Frost looked up as ET2 Door rushed into the office, "May I help you?"

"I hope so! I've got a problem!"

“Lay it on me.”

“I’ve got to get a new ID card for my wife.”

“Did she lose her card?”

“No. Those people back at the base took it away from her—said it wasn’t any good!”

“Do you know why?”

ET2 Door unfolded a letter and reread a portion of it. “She didn’t say. She had gone to the commissary, and the man at the door took it—said it wasn’t any good.”

PNSN Frost thought for a moment, shook his head, and turned to PN3 Doe, “Doe, I need some help. Door just received a letter from his wife, and she said that her ID card was taken by the commissary. She was told it wasn’t any good.”

As PN3 Doe came to the counter, he asked PNSN Frost to get Door’s record. “Your wife didn’t say why the card wasn’t good?”

“No, she didn’t.”

“Do you know if it had been damaged in such a way that it would appear to have been altered?”

“I don’t think so. At least, she never said anything about it. I don’t think it’s right for the card to be taken away from her. I’m a million miles from home; and she can’t go to the commissary, the exchange, or the hospital. She’s going to have a baby, and she has to go to the hospital for regular checkups. I think it’s a raw deal.”

“It does sound like it, but there has to be a reason. Let’s see if we can figure out what the problem is.” After PNSN Frost got the record, PN3 Doe opened it and began to leaf through the pages. He located the DD Form 1172 (application form for dependent’s ID card) and glanced over it. “She got the card just over a year ago. Is this information correct?” He turned the record so that Door could read the form.

“Yes; she never had any trouble with her card before,” ET2 Door replied.

Then an entry on the form caught PN3 Doe’s eye—the expiration date! It was a month ago! Quickly, he turned to the enlistment contract. It had the same expiration date, but there was also an extension agreement. “Door, have you ever filled out a new application form?”

“No. Should I have?”

“I’m afraid so. Looks like we both goofed. Her card was issued with the expiration date of your enlistment.

That was a month ago. You’re now on your extension. That explains why the card was picked up. It wasn’t any good; it had expired. Well, we can correct this problem.” PN3 Doe obtained the forms from the cabinet and returned to the counter. “It will just take a minute for me to type a new application. Then you can sign it, and we’ll get it in the mail to your wife. She can take it to the personnel office on the base, and that office will issue her a new card.”

ET2 Door was silent for awhile, then he said, “We won’t have any mail leaving this ship for over a week. Then it will take up to 2 weeks for the letter to reach her. She will be without a card for almost a month. Can’t she get it any quicker than that?”

PN1 Seaman had followed part of the conversation while he was going through the incoming mail. Upon hearing ET2 Door’s question, he came over to the counter. He greeted ET2 Door, turned to PN3 Doe, and asked, “Anything I can do?”

“Maybe.” Briefly PN3 Doe related the problem. “Door just had a letter from his wife. The base commissary picked up her ID card because it had expired. His extension went into effect last month and no one thought to get a new card for her. I’m filling out the application now, but as Door just said, getting her a new card is going to take some time. Is there a faster way for her to get her card?”

PN1 Seaman replied, “Yes, there is. We can send a message. You have handled this problem very well, Doe. Go ahead and finish the application, have it signed, and leave it and his record on my desk. I’ll have to check a couple of references; then we’ll draft a message that will authorize the issuance of a new ID card. The message will go out today, and Mrs. Door should get it tomorrow or the next day. She can take it to the base personnel office as soon as she receives it, and that office will issue her a new card. Oh, don’t worry about her medical care. She can obtain that without her ID card. She just has to sign a form at the hospital.”

In this instance, PNSN Frost sought help for a situation that he couldn’t handle. PN3 Doe responded well to the customer, but he was providing a routine solution for a problem that was more than routine; however, he quickly accepted PN1 Seaman’s offer to help. Although PN1 Seaman could have offered to help sooner, he was able to provide the proper solution. ET2 Door was fortunate to have had his problem resolved by teamwork at its best.

When you are faced with a problem that exceeds your ability to solve—use the team’s ability.

## **FINDING SOLUTIONS WHEN HELP IS UNAVAILABLE**

You will experience times when you are temporarily on your own with no one to whom you can turn for help. In such instances, you must still recognize the limits of your ability and be sure that your actions are correct. Had PNSN Frost been alone in the office when ET2 Door came in, he would have faced this type of situation. Probably, he could have groped his way to the solution decided upon by PN3 Doe, but that would have been the more difficult route to take.

In this type of situation, you can still benefit from teamwork. When you have a question, take either of two actions: (1) make a note of your question so that you can ask for help at a later time, and then take action after you receive that help; or (2) have the customer return when a qualified person will be present. In either case, be sure the customer understands why you are not taking action at that time. The best way to ensure that is by admitting, "I don't know, but I'll find out."

## **IMPROVING TEAMWORK**

Now that we have looked closely at the team members' responsibilities to the contact point, let's examine some of the ways of improving contact point effectiveness. Improving contact point effectiveness is not the sole responsibility of the supervisor, or the senior petty officer, though that person must bear the bulk of the responsibility.

Studies of management have shown that the most efficient supervisors delegate responsibility for specific duties as soon as personnel demonstrate their ability to handle them. That does not lessen those supervisors' overall responsibility, but frees them from routine matters, which enables them to give more attention to nonroutine problems. Delegating responsibility also provides excellent training for junior members.

Delegating responsibility meets an important need in the member—recognition. The member who has acquired the ability to handle more difficult jobs and has indicated a willingness to assume more responsibility should be given greater responsibility. Giving a member greater responsibility provides an incentive for further improvement.

## **PLANNING THE LAYOUT OF THE CONTACT POINT**

Large sums of money, a lot of talent, and an endless volume of energy went into the overall design, purpose,

and function of the Apollo capsule. Combined these components provided not only the technical means for the mission, but also an environment in which astronauts could perform at their peak ability. Few contact points have been designed this carefully. As a rule, the Navy merely provides a space to be used as the contact point; it is up to the members of the contact point team to make it functional.

A physical layout that provides maximum efficiency and convenience for the members but disregards customer accessibility will operate under a handicap. The opposite is equally true. Therefore, the physical arrangement (location of desks, counters, etc.) must provide for both the customers and the team members.

Specifying a layout for furniture or traffic patterns is impractical. However, in planning the furniture layout and traffic pattern, team members must consider the comfort of the customers as well as their own. Planning must not be based on the idea that "I'm the one who has to do the work; if someone has to be uncomfortable, let it be the customer." That attitude is not compatible with providing good service. Observe the following guidelines in planning the layout of furniture and traffic patterns:

- Provide a traffic pattern that prevents a line of customers from extending through a doorway.
- Provide a counter or table on which customers may fill out forms.
- Provide chairs at contact points ashore that are visited by dependents.
- Provide a measure of privacy in the arrangement of the contact point for those times when customers must provide information of a personal nature.
- Designate someone at large contact points to greet customers and direct them to the proper place. That should keep customers from waiting in a line only to discover later that they were in the wrong line.

## **CREATING A POSITIVE ATMOSPHERE**

We have already discussed the influence that the member exerts on the contact point. Now let's consider the other side of influence. How much does the atmosphere of the contact point (the general attitude of

all team members) affect each team member individually?

As the supervisor or other senior member of a team, you exert the greatest amount of influence on that team. As the leader, not only are you the one who sets the example for the rest of the team, you are the one who creates either a positive or a negative atmosphere. Refer to Case No. 3. LPO Brush provided a negative atmosphere through two poor work habits. First, he used profanity and allowed other members to use it. Second, he measured office effectiveness by empty baskets rather than by the quality of response to customer needs.

A contact point representative may read chapter 3 of this book carefully and fully intend to implement its “do this” and “don’t do that” advice. However, the extent to which the representative may apply that advice depends largely on the contact point atmosphere. You must take the lead in developing and reinforcing an atmosphere that improves teamwork.

Each team develops its own standards for performance and behavior. These standards are a composite of the standards of all of its members, which must be acceptable by the contact point supervisor. The team then exerts its influence on each member to conform to those standards. New members being indoctrinated in their duties are aware of the attitude of the team toward those standards. As they develop their job skills, they will likely develop and accept a similar attitude.

Setting a good example is the best possible method of creating a positive atmosphere. When team members see that you have a positive attitude toward work, they will follow your example. As new members develop their work habits, they will look not only at the example you set, but at the example set by other team members.

## ENCOURAGING THE ACCEPTANCE OF RESPONSIBILITY

Chapter 1 stated that there are no unimportant jobs when you are performing a personal service or supplying a personal need. You can carry this statement a step further— **there are no unimportant jobs**. The output from a particular job may have doubtful value, but the performance of that job is important to the performer. The performer must be able to see some worth in the job to maintain a sense of personal worth. If convinced that the job has no purpose or value, the

performer assumes that the supervisor considers the job to be of little value.

At times, a person’s ability far exceeds the ability required to perform an assigned job. When you make such assignments, explain the reason for the assignment and the value of the job. That will help confirm the person’s sense of personal worth and, thus, improve teamwork. The following are examples of explanations you might use:

- This job isn’t as challenging as other jobs that you have had in the past but, it is certainly as important. To make this point, it is part of our training rotation. I know that you will do well.
- This work must be kept on schedule; I trust you will do that in my absence.
- You’ll be starting your new assignment next week. In the meantime. . .

You may stimulate the initiative of a new member by using the job assignment itself. Let the member know that this is the first in a series of assignments that will increase in responsibility with each job change.

You may stimulate the initiative of a new member by using job assignments as the first in a series of increases in responsibility. The Navy’s most valuable asset—people—is wasted when they are told to “look” busy. Supervisors who instruct their people to look busy demonstrate their own lack of initiative (poor planning) and destroy initiative in team members.

Supervision can stimulate a team to better performance, or it can smother any initiative. Suppose a supervisor asks, “Can’t you people do anything on your own?” Then the supervisor constantly looks over the workers’ shoulders and criticizes their work. The supervisor’s action has answered the question: No, the members can’t do anything on their own; the supervisor won’t let them.

You must keep the lines of communication open. Though you must encourage members to work on their own, you must assure them that they can come to you for answers when the need arises. Your response may vary, depending upon the need and the person, but it should not lead the member to an endless, aimless search.

You can take three steps to encourage team members to assume responsibility:

1. Recognize their ability.
2. Set goals for them.



3. Acknowledge their achievements.

### **Recognizing Ability**

To recognize abilities is to recognize the individual. If we were to randomly select a Navy rating and then from that rating select a rate, these people would be as different in their abilities as they are in appearance. Matching job requirements to individual abilities is just good management. This job match should not be looked upon as being permanent, but as a logical beginning for training.

### **Setting Goals**

“This instruction just came in. I want you to study it.” This supervisor has given the team members one reason they should read the instruction: “I want. . .” This approach gives them no motivation to read it; they do not know how, why, or when to use the instruction? A different approach would provide more motivation: “We just received this instruction covering new pay procedures that will go into effect the first of the month. I’ll route it around so that all of you can read it. Next week, we will have a training session on the contents.” Using this approach, the supervisor has told them how, why and when.

Goals must be meaningful and realistic if team members are to consider them seriously. Ideally, goals should be set just above the level that the person is currently achieving. If they are too low, there is no challenge—the goal has already been met. If they are too high, the member is likely to reject them. If failure is certain, why go to the trouble of trying?

Goals may be set for individuals or for the team. They may be set as a part of, or in connection with, the division training program.

### **Acknowledging Achievements**

Rare, indeed, is the person who will conscientiously do a job, day after day, without some recognition. Members normally receive recognition for performance at the outstanding performance level. However, those who perform considerably below the level of outstanding also need to receive recognition. Make an effort to recognize those personnel who perform at a less notable level. The following are some examples of the positive effects of such recognition:

- The new member is just learning the job. Recognition of achievement may provide a needed boost toward increased ability.

- The “plodder” has shown unusual initiative. Recognition may be the incentive needed to pull that person out of a rut.
- The capable, dependable member always does a good job. Recognition communicates your awareness of and your appreciation for that person’s performance.

For whatever reason recognition is given, it must be honest. The member usually knows when performance has been satisfactory and when it has not. Regardless of whether the job is good or bad, say so. If for some reason it happens to be bad, say why. Indiscriminate flattery can be as bad as no recognition. After all, if the member gets a pat on the back for every job—good or bad—where is the incentive to do a good job?

## **PREVENTING MISTAKES**

Improving teamwork as a supervisor involves helping team members avoid mistakes without interfering with their performance. One way to help prevent mistakes is to make a constant check of every job as it is being done. A better way is to assign members to jobs only after you feel they are capable of doing the work. Then check completed work as a regular procedure, and make sure members know that you check it. That will enable you to detect any errors so that you can reintroduce policies and procedures needed to help members avoid carelessness.

Earlier in this chapter, we discussed how PN1 Seaman demonstrated this type of supervision in the example of the expired ID card. He did not interfere as his coworkers tackled the problem and identified the cause. When he saw that the best solution had not been found, he gave PN3 Doe an opportunity to ask for advice. If he had not asked, PN1 Seaman could then have suggested the possibility of a message. As important as his solution was to ET2 Door, his tact in handling the situation was even more important to the team. In no way did he belittle what the team had done, and he used a work situation as a training opportunity.

Here is another example of supervision that improved teamwork without interfering with performance. A group of PNs were receiving training as interviewers. As a final part of the interviewers’ training, they conducted actual interviews at a recruit training command. They conducted the interviews in small interview booths with only the recruit and the trainee present. The supervisor monitored the trainees’ performance through a concealed microphone in the interview booth. The interview validity was not affected

since the recruit was not aware of the monitoring. If a trainee did not perform an interview properly, the supervisor casually entered the booth and made a plausible excuse to consult the interviewer. The supervisor then sent the recruit out for a 5-minute break and, while the recruit was out, made suggestions to the interviewer for improving the interview technique.

Supervisory responsibility is inherent as portrayed by your rating badge. The higher the rate, the greater the responsibility. You don’t gain this responsibility by only pointing out mistakes. You must do much more. You must be available for advice or to do whatever it takes to get the job done.

Members often make mistakes and errors in judgment because they want to avoid the displeasure or sarcasm some seniors display when asked for help. When that happens, who is at fault? But beyond fault, who is the loser when a mistake is made? Although the senior is at fault, the entire team suffers. Consider the following example:

MSSN Doe is fixing spaghetti sauce for the noon meal. Everything is coming along fine until he starts to add the seasoning. The recipe card is smudged and all he can read is: Pepper, cayenne 2 T. Does that “T” mean teaspoon or tablespoon? He starts to ask the watch captain, then hesitates. The last time he asked for help, he received several pointed remarks about his ancestry. In the end, the question still went unanswered. Looking back at the card, he mumbles to himself, “That’s a fairly large batch of sauce, and a teaspoon is pretty small—it must be a tablespoon.”

MSSN Doe finishes the sauce, and the sauce finishes the crew—no doubt that he should have used a teaspoon.

## **MEETING TRAINING NEEDS**

In trying to improve teamwork, supervisors often substitute criticism for proper training. Criticism is a reflection of poor supervision and usually results in unfair treatment of team members. A better way to improve teamwork is through training. The excuse “We don’t have time for a training program” is not valid. If the contact point is that busy, you can’t afford not to train.

We will not go into methods and techniques of training; adequate materials are available on these topics. Rather, we will offer some ideas that you can use in the informal training situation.



Too often we limit the concept of training to classroom instruction. We forget that training is a constant process in everyone's development. That may be even more apparent in the Navy because of the frequency of transfers. There is always someone transferring out and a new replacement reporting in. Even though skilled in the job, the replacement must learn local procedures and adjust to local problems and working conditions.

**Each new member presents an immediate need for training.** The extent of the training needed is determined by the person's prior training and experience. The training needs may be met through three important steps:

**1. Greeting the member pleasantly.** While this act of courtesy is not training in the strictest sense, it sets the attitude of the new member toward the team and

opens the door for other team members to follow the example.

**2. Teaching the basics immediately.** The supervisor can quickly determine the new member's need for this training from information gained through an interview. The responsibility for providing this training may be assigned to other members of the team; the method used must be appropriate for each individual.

**3. Providing follow-up.** This step is just as necessary as the training step, from both the viewpoint of the supervisor and the new member. A follow-up lets the supervisor know how the member is progressing and what additional training is needed. It shows the supervisor's interest in the members progress and opens lines of communication.

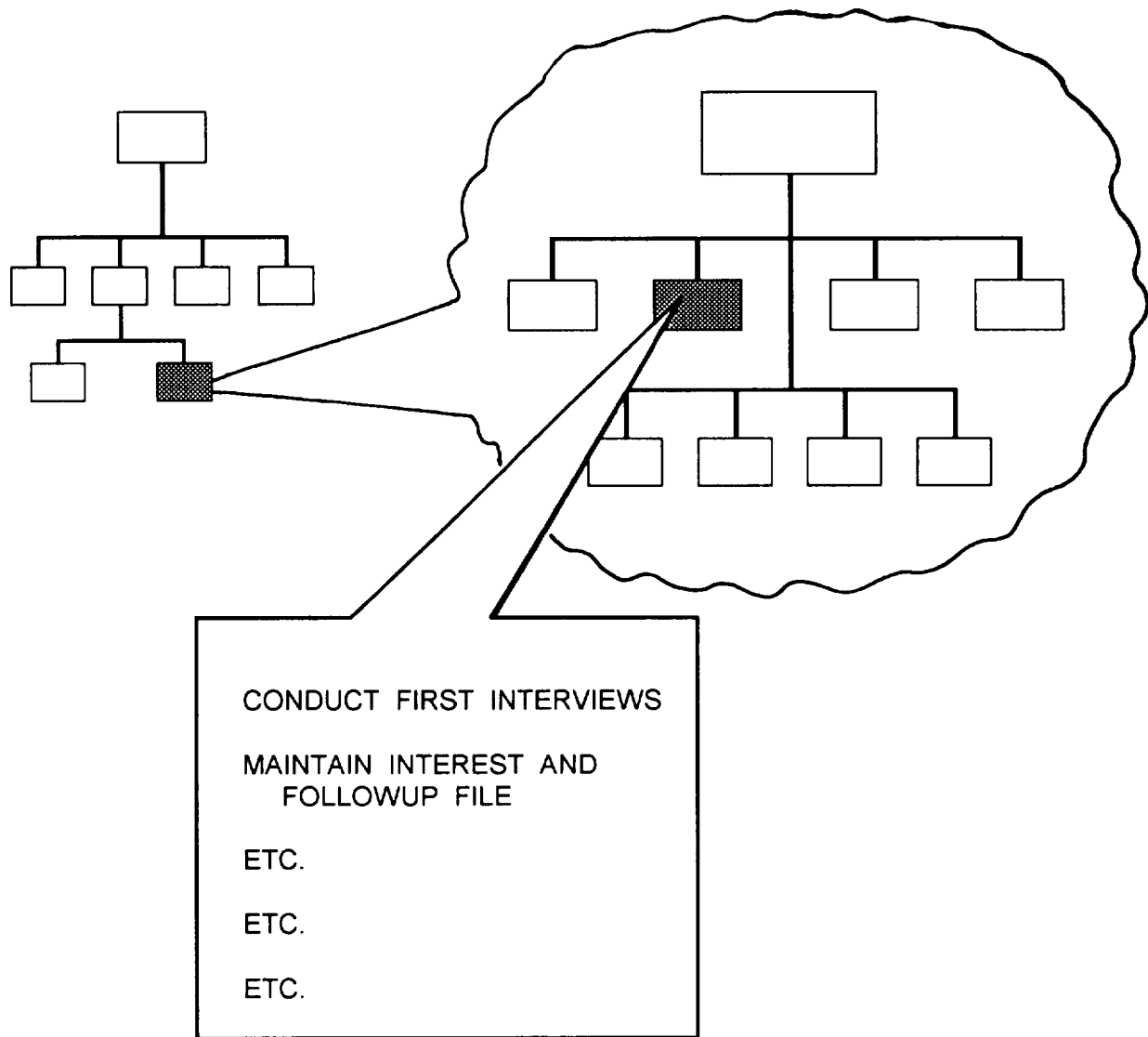

Supervisors must be able to provide individualized training as well as group training. To do that, they must be accessible to the member and be willing to take the time to help the member when needed. They will quickly realize the compensation for this greater emphasis on training in the reduction of time they spend supervising. They need no outstanding ability or special training for this phase of supervision, but they must develop the following skills:

- Listening patiently. Quite often supervisors may feel that the person is taking too much time explaining, so they stop listening. Thus, they may miss the main reason for the member's communication with them.

- Refraining from hasty condemnation or conclusion. Supervisors must get the whole story before making decisions.

- Refraining from arguing. Arguing with a subordinate does not solve problems, and it may well lead to additional ones. One of the responsibilities of supervisors is the exercise of authority. After observing the two points above, a supervisor who reaches a decision and feels there is no justifiable alternative should stick with that decision. Argument will only intensify the member's reluctance to accept that decision.

- Paying attention not only to the content of the remarks but to the overtones and body language. What the member feels but does not say may be more important than what is actually being said.

- Listening for what the person may be reluctant to say or cannot say without assistance.

Learning is best accomplished when the instruction sets a pattern of primacy. That is, it moves from known to unknown, simple to complex, and complex to simple; or it is organized by performance steps. In other words, the trainee should learn how to follow a recipe and operate an oven before attempting to bake a cake. If instruction is arranged properly, the trainee can refer back to what was previously learned to better understand what is being presently taught. When this method is applied, the member learns more, learns it faster, and remembers it longer.

The use of training sessions can achieve the following results:

- Stimulate trainees to perform self-evaluation.
- Develop trainees' awareness of their knowledge level.

- Provide trainees with needed instruction.
- Encourage trainees to exchange ideas and knowledge.

As the leader of an informal training session, you must keep the group headed in the right direction. You should direct discussion sessions toward a stated or an agreed-upon goal. Training sessions provide excellent opportunities for frank, open discussions of mechanical problems as well as problems with work flow, time allocation, future work loads, and special jobs. The leader of informal training must be vigilant in preventing the session from losing focus. No one wants to listen to someone's gripes during a training session.

Role playing can be an effective means of developing face-to-face skills and of stimulating discussions about problems faced by certain ratings. When properly introduced to the participants, it has several possible uses in the training program. Since participants may be self-conscious at first, your first efforts in using role playing may not get off the ground. However, when participants realize they are not playing games, they will gradually assume their roles. Then role playing will achieve the desired results of training.

With an experienced member playing the role of the customer and the inexperienced members serving as the contact point representatives, you can provide real life experiences for members to solve. Select training problems that are not intended to overwhelm the trainees but to acquaint them with typical problems. Make sure each situation has a specific training objective.

## **DEVELOPING THE "WE" CONCEPT**

People who are "loners" are determined to get to a destination without owing anyone for anything. They refuse to help others, belittle everyone else's accomplishments, and avidly point out others' mistakes. These people have great difficulty working as a member of a team.

Teamwork improves only when all members overcome this problem by learning to view themselves as part of the team. To help them do that, encourage them to begin thinking in terms of we:

We members of the contact point. . .

We members of the ship or station. . .

We members of the Navy . . .

Help them to see that being a member of a team doesn't take away from their importance. Help them to

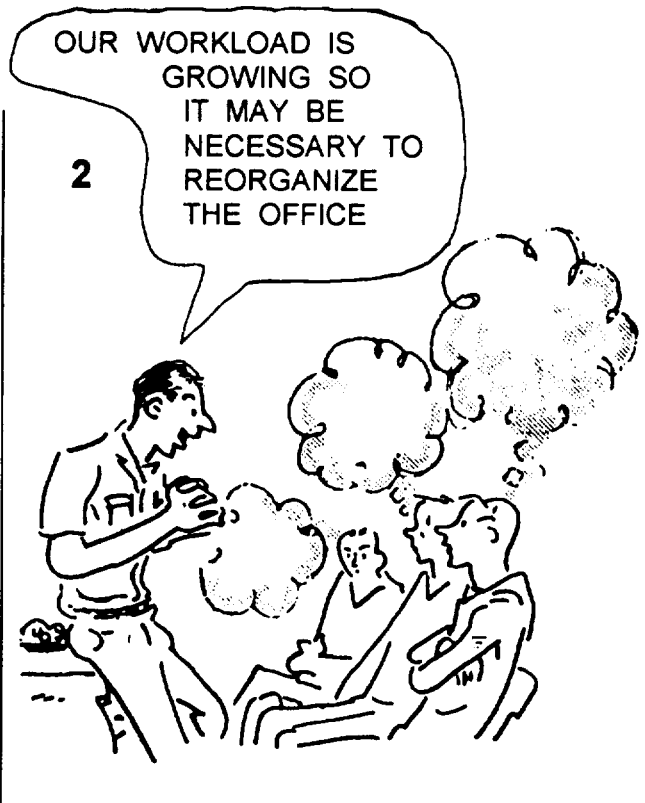

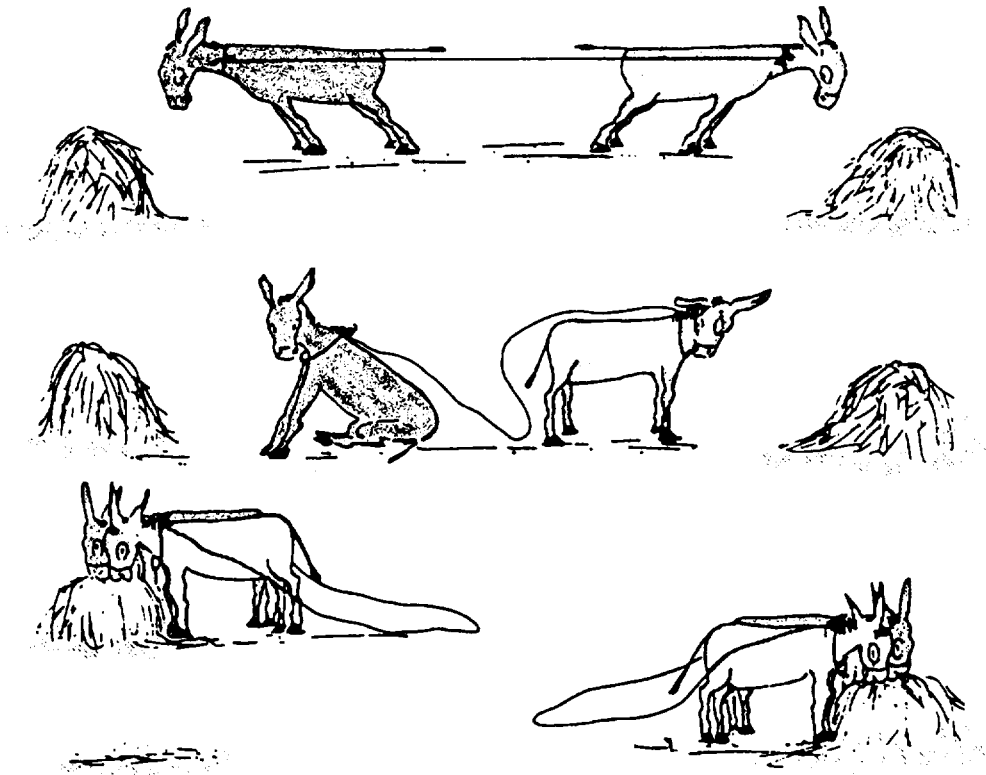

see that working as a member of a team improves the effectiveness and productivity of the contact point.

### DEVELOPING CONFIDENCE

Confidence is that quality that enables us to make decisions or to take actions without the constant fear that we might be wrong. It doesn't rule out mistakes, but we are less likely to make them when our evaluation of facts is not muddled by nagging doubts. **Confidence also enables us to face a mistake, admit it, correct it, and then go on to the next job with the assurance that we can handle it.** When team members develop confidence in their abilities, they become willing to help their teammates as well as the customers. Team members working together is what teamwork is all about.

### BENEFITING FROM MISTAKES

You benefit from incorrect decisions and actions if you learn how to avoid repeating your mistakes. Many supervisors recognize that when they say, "I don't condemn mistakes as long as you don't continue to make them." When team members recognize the consequences of a mistake, they are less likely to repeat the same mistake. Therefore, a mistake, discovered and corrected, helps to improve teamwork.

When an assistant burned out the filament of an experimental light bulb by applying too heavy a charge of electricity, Thomas Edison remarked, "Don't call it a mistake; call it an education." Adopting this positive attitude enables us to obtain the maximum value—for the customer and for ourselves—from our work.

### MAKING A PERSONAL INVENTORY

Now that you have completed reading this manual, you probably have been able to relate some of the situations to experiences you have had. Have you also tried to find similarities between the attitudes that you possess and those shown in the examples and discussions?

The questions that follow have been adapted from the checklist used in chapter 2; use them to make a personal inventory of your skills as a contact point representative:

- Do I present a good personal appearance at the contact point?
- Am I familiar with all the responsibilities of my rating?
- Am I competent to manage all the responsibilities of my current assignment?

- Have I organized my work and time so that I give the most efficient service possible?
- Am I aware of the importance of records, and do I keep them current and complete?
- Do I know the content and arrangement of publications regularly used at my contact point?
- Do I speak and write clearly and understandably to the best of my ability?
- Do I accept the responsibility for doing my job as it should be done so that constant supervision is not necessary?
- Do I show consideration for my coworkers by what I say and do?
- Do I treat each customer as an individual with individual needs?
- Do I analyze customers' problems correctly so that the first action I take is the proper action?
- Do I provide the same quality of service to all customers regardless of their grade, rate, or personal characteristics?
- By not handling a problem as I should, do I cause delays or other inconveniences to the customer?
- When I answer a customer's question, am I absolutely certain that the information is correct?
- Does my response to the customer reveal a pleasant, friendly nature?
- Does my response to the customer show a willingness to help?
- Does my response to the customer indicate concern for the problem?
- Does my response to the customer instill confidence in my ability?
- If I were the customer, would I be satisfied with the service I received?



## APPENDIX I

# REFERENCES USED TO DEVELOP THE TRAMAN

*Human Behavior*, NAVEDTRA 10058-C1, Naval Education and Training Program Management Support Activity, Pensacola, Fla., 1989

Robert W. Grenier, *Customer Satisfaction Through Total Quality Assurance*, Hitchcock Publishing Co., Wheaton, Ill., 1989.

Southern Bell Telephone Company, *Your Guide to More Effective Telephone Techniques*, Southern Bell Telephone Company, Pensacola, Fla., 1992.

Southern Bell Telephone Company, *Your Telephone Personality*, Southern Bell Telephone Company, Pensacola, Fla., 1992.

*Team Approach Manual*, Naval Medical Command, Washington, D.C., 1989.





# INDEX

- A**
- Assistance, providing, 3-16
  - Attitudes, 1-2, 3-2
    - behavior resulting from, 1-8
    - cooperative, 1-8
    - coping with negative, 3-4
    - projecting, 3-2
    - reflected in pride, 1-7
    - reflected through courtesy, 1-7
    - toward the Navy, 1-2
- C**
- Communication, barriers to, 3-8
    - confusing terminology, 3-10
    - cultural differences, 3-9
    - language that reflects prejudice and bigotry, 3-10
    - physical problems, 3-9
    - speech habits, 3-10
  - Complaints, 3-12
  - Contact, face-to-face, 1-1,2-1
  - Contact point, 1-5, 3-1
    - manning the, 3-1
    - team, 4-1
  - Contact point representative, 2-1, 3-6
    - as a team member, 4-1
    - knowledge required of, 3-14
    - limitations of, 3-15
    - personal inventory for, 2-1
    - pitfalls to avoid as, 3-6
    - responsibilities of, 1-1, 3-1
    - role of, 2-2
  - Cooperation, 1-8
  - Courtesy, 1-7
  - Customers, 1-4
    - assistance to, 3-16
    - giving the amiable runaround to, 3-11
    - making a good first impression on, 3-1
    - overstepping your bounds with, 3-11
    - promises to, 3-11
    - reducing waiting time of, 3-13
    - responding to, 3-10
    - role of, 2-2
    - showing apathy toward, 3-12
- L**
- Limitations of contact point representatives, 3-15
- N**
- Needs, of Navy customers, 1-3, 2-1, 3-4
    - determining specific problems associated with, 3-5
    - meeting, 1-3, 3-4
    - meeting unexpressed, 3-17
    - responding to, 2-1
- Q**
- Questions, 1-8, 3-9, 4-12
    - answering, 1-8, 3-11, 3-17
    - developed from personal inventory checklist, 4-12
    - finding answers to, 3-15
    - phrasing, 3-9
- R**
- Recordkeeping, 3-20
  - Regulations, 3-14
  - Representatives. See Contact point representatives
  - Responsibilities of contact point representatives, 1-1, 2-1, 3-1, 4-1
    - answering questions, 1-8, 3-11, 3-17
    - as a team member, 4-1

Responsibilities of contact point representatives—continued

communicating clearly, 3-8, 3-19  
determining specific problems associated with needs, 3-5  
explaining future steps, 3-19  
explaining results of actions, 3-20  
filling out forms, 3-19  
giving simple explanations, 3-18  
knowing alternatives, 3-16  
knowing members' rights and privileges, 3-14  
knowing regulations, 3-14  
knowing your limitations, 3-15  
maintaining self-control, 3-5  
making a good first impression, 3-1  
making promises, 3-11, 3-20  
meeting customer needs, 1-1, 2-1, 1-3, 3-4  
presenting a good appearance, 3-2  
projecting attitudes, 3-2  
recordkeeping, 3-20

Responsibilities of contact point representatives-Continued

referring customers to other sources, 3-20  
using telephone courtesy, 3-18

Rights and privileges, 3-14

**S**

Service, customer, 1-1, 2-1, 3-12

effect of good or bad, 1-3  
examples of, 2-2  
providing, 1-1, 2-1, 3-14  
required level of, 1-3  
responsibility for, 1-1  
team approach to, 4-1  
terminology, 1-4

Skills, face-to-face, 1-6

**T**

Teamwork, 4-1

achieving, 4-1  
improving, 4-5

---

---

# *Assignment Questions*

---

---

**Information:** The text pages that you are to study are provided at the beginning of the assignment questions.



# ASSIGNMENT 1

Textbook Assignment: *Navy Customer Service Manual*, chapters 1 through 4, pages 1-1 through 4-13.

---

- 1-1. Naval personnel have the same customer service needs as civilian personnel.
1. True
  2. False
- 1-2. Navy members have the privilege of choosing which, if any, of the following details concerning their duty assignments?
1. Location
  2. Occupation
  3. Training
  4. None of the above
- 1-3. What is the Navy's most valuable asset?
1. Fleets of ships
  2. Shipyards/land stations
  3. Fiscal appropriations
  4. Capable people
- 1-4. For the Navy to fulfil its mission, members must often sacrifice their freedom of
1. speech
  2. choice
  3. religion
  4. expression
- 1-5. Improvement of overall customer service depends on improvement in which of the following specific areas of customer service?
1. Timeliness
  2. Human relations
  3. Work organization
  4. Knowledge of rating
- 1-6. Which of the following terms refers to a person who has a need for services?
1. A patient
  2. A customer
  3. A client
  4. Each of the above
- 1-7. Which of the following physical locations is NOT an example of a "contact point"?
1. The legal services office
  2. The ship's store
  3. The radar room
  4. The general storekeeping office
- 1-8. At which of the following contact points would the customer be appropriately called the "client"?
1. Substance abuse office
  2. Disbursing office
  3. Sickbay
  4. Personnel office
- 1-9. Members of which of the following ratings would be assigned to a contact point that provides indirect services?
1. HM
  2. BM
  3. YN
  4. PC
- 1-10. Which of the following terms indicates the ability to use one's training effectively?
1. Skill
  2. Courtesy
  3. Attitude
  4. Cooperation

- 1-11. The structure of the Navy tends to foster which of the following attitudes in its members?
1. Personal
  2. Impersonal
  3. Positive
  4. Negative
- 1-12. Attitude can be described as the tendency to move away from or toward a situation.
1. True
  2. False
- 1-13. An aircraft mechanic spots a loose wire during a preventive maintenance check on a jet engine but does nothing about it. Which of the following attitudes could prompt such an act of neglect?
1. Positive
  2. Negative
  3. Cooperative
  4. Impersonal
- 1-14. Doing your best in any job requires that you have which of the following personal characteristics?
1. Pride in yourself
  2. Pride in your ability
  3. Pride in your job
  4. Each of the above
- 1-15. People are people, and you can't change human nature.
1. True
  2. False
- 1-16. When the consequences of a situation are pleasant or desirable, a person would have which of the following attitudes toward that situation?
1. Positive
  2. Negative
  3. Cooperative
  4. Uncooperative
- 1-17. Before you can have a proper attitude toward others, you must first develop a proper appreciation of which of the following people?
1. The supervisor
  2. The customer
  3. Your coworkers
  4. Yourself
- 1-18. If members only do what they are told to do when they are told to do it, they are reflecting which of the following traits?
1. Lack of training
  2. Lack of skill
  3. Lack of pride
  4. Lack of cooperation
- 1-19. Common courtesy is best described as a voluntary expression of respect for
1. protocol
  2. another's rights or feelings
  3. one's own rights or feelings
  4. tradition
- 1-20. Working with other team members to improve individual performance and the overall efficiency of the organization reflects which of the following types of attitudes?
1. Cooperative
  2. Enthusiastic
  3. Courteous
  4. Indifferent

- 1-21. The things we choose to do or not to do results from which of the following personal characteristics?
1. Habits
  2. Appearance
  3. Self-control
  4. Attitude
- 1-22. The customers' opinion of you as a contact point representative is based primarily on which of the following observations?
1. Your total workload
  2. Your appearance
  3. Your response to their needs
  4. Your friendliness
- 1-23. A customer comes to you with a problem and asks, "Can you help me?" You reply, "Yes, I can." In addition, your response should reflect an attitude that implies which of the following statements?
1. And I will
  2. As soon as time permits
  3. As soon as the information is received
  4. But it will not be easy
- 1-24. You should concentrate on developing which of the following traits and abilities?
1. A stern attitude with customers
  2. A genuine interest in customers' problems
  3. A sense of humor
  4. A superior attitude
- 1-25. Customers receiving services at your contact point usually observe enough of your work to make a completely fair evaluation of you, the contact representative.
1. True
  2. False
- 1-26. If you have a customer who wants to discuss a personal problem, you should treat that person as an individual with what kind of need?
1. Routine
  2. Special
  3. Unimportant
  4. Nonessential
- 1-27. A customer's first impression of a contact point representative is usually based on which of the following characteristics?
1. Mannerisms
  2. Speech
  3. Appearance
  4. All of the above
- 1-28. A customer's first impression of the contact representative will normally be generalized to what specific group?
1. The entire office
  2. The personnel in charge of the contact point
  3. The rating of the contact representative
  4. The ship's company
- 1-29. The practice of "speaking down" to a customer implies you consider that person to be of what status?
1. Stupid
  2. Slow to understand
  3. Less than your equal
  4. Less educated than you
- 1-30. The use of which of the following terms reflects prejudice?
1. Chief
  2. Deck ape
  3. Seaman
  4. Sailor

- 1-31. Placing individuals into groups that you regard as inferior defines what term?
1. Jumping to conclusions
  2. Stereotyping
  3. Prejudice
  4. Racism
- 1-32. When you must serve a customer who is emotionally upset, you should act in which of the following manners?
1. Detached and stern
  2. Calm and confident
  3. Enthusiastic and easygoing
  4. Composed and skeptical.
- 1-33. Ensuring a Navy dependent receives the services to which he or she is entitled is the responsibility of which of the following people?
1. The dependent's contact point representative
  2. The dependent's sponsor
  3. The sponsor's leading petty officer
  4. The customer
- 1-34. You should react to an unpleasant customer in which of the following ways?
1. Repay rudeness with rudeness
  2. Keep the contact as impersonal as possible
  3. Ignore both the manner and attitude and concentrate on the problem
  4. Both 2 and 3 above
- 1-35. Mistakes made by Navy contact point representatives in their handling of customer needs grow out of negative attitudes toward which of the following individuals?
1. The customer
  2. The supervisor
  3. Their coworkers
  4. Each of the above
- 1-36. When you jump to a conclusion, you are actually making a decision based on which of the following factors?
1. Incomplete information
  2. Misunderstanding
  3. Apathy
  4. Rudeness
- 1-37. When a contact point representative reacts adversely to a customer, the representative is most likely reacting to which of the following characteristics of the customer?
1. Appearance
  2. Speech
  3. Attitude
  4. Gestures
- 1-38. To properly identify what a customer is trying to convey, you should use which of the following methods?
1. Ask them to put their problem in writing
  2. Ask them to explain the problem to someone else
  3. Ask them to come back at a later date
  4. Ask them questions in a tactful, skillful manner



- 1-39. A customer came to you for advice but left disappointed. Which of the following circumstances would NOT have caused this situation?
1. The customer felt rushed
  2. You used unfamiliar terms
  3. The customer explained the problem in great detail
  4. Other problems were bothering the customer
- 1-40. Which of the following personal characteristics interfere with effective communication?
1. Cultural differences
  2. Physical problems
  3. Speech habits
  4. Each of the above
- 1-41. Which of the following speech habits would increase understanding?
1. Profanity
  2. Exaggerated accent
  3. Speaking very slowly
  4. Slurred pronunciation
- 1-42. What is the purpose of manning the contact point?
1. To provide a friendly atmosphere
  2. To provide a service
  3. To provide an atmosphere to put the customer at ease
  4. To provide a dynamic environment for training
- 1-43. Disagreeing with a customer about official Navy policy could result in which of the following customer reactions?
1. Anger
  2. Resentment and frustration
  3. Loss of respect
  4. Relief
- 1-44. Routines or procedures provide which of the following benefits?
1. They help identify problems
  2. They increase customer satisfaction
  3. They enable us to do jobs faster
  4. They improve the customer's self-esteem
- 1-45. Which of the following factors causes apathy on the job?
1. The job has a defined purpose
  2. The job is demanding
  3. The job leads to challenging responsibility
  4. The job lacks opportunity for advancement
- 1-46. Which of the following methods should be used to speed up service and reduce the customer's waiting time?
1. Limited services
  2. Written customer requests
  3. Appointments
  4. Walk-ins
- 1-47. The contact point is governed by volumes of regulations, manuals, and directives. Since you cannot memorize their contents, you should concentrate on learning what information?
1. The proper references in which to find answers
  2. The answers to all routine questions
  3. The contents of your most important reference
  4. The contents of all important reference material

- 1-48. Benefits are to be afforded impartially to all eligible members, but when may they be omitted by a command?
1. When the ship size does not allow for service
  2. When the station location is such that it does not permit for the service
  3. When the contact point is not staffed for the service
  4. All of the above
- 1-49. Which of the following circumstances is a reason to impose temporary limitations on the operations of a contact point?
1. Loss of personnel
  2. Oversensitive personnel
  3. Equipment in good working order
  4. Unusually light workload
- 1-50. The contact point representative's reaction to a customer arriving at the contact point can have either a positive or an adverse effect. Which of the following reactions would have an adverse effect on the customer?
1. Being ignored
  2. Being asked to wait in line
  3. Being asked to come back later
  4. Being asked to fill out forms
- 1-51. Customers deserve the courtesy of an answer to which of the following types of questions?
1. Poorly constructed
  2. Complex
  3. Ridiculous
  4. Each of the above
- 1-52. A contact point representative who must answer the phone while providing service should handle the situation in which of the following ways?
1. Keep one of the customers waiting
  2. Ask the customer who has phoned if you may call him or her back
  3. Try to help both customers at the same time
  4. Ask another customer for help
- 1-53. The guiding principle when using the telephone should be to remember you are talking to a
1. telephone
  2. person
  3. stranger
  4. person who is not busy
- 1-54. When helping a customer on the telephone who has difficulty with the English language or who has a speech defect, what action should you take?
1. Give the customer the same consideration as you would when talking face to face with that person
  2. Ask for the customer's supervisor
  3. Tell that person to get someone else to talk for him or her
  4. Ask the person to come to the contact point
- 1-55. Seaman Door works for Captain Pistol in the Administrative office. Which of the following responses should Seaman Door use when answering the phone?
1. "Hello, Seaman Door speaking."
  2. "Admin office; may I help you?"
  3. "Seaman Door here; may I help you?"
  4. "Captain Pistol's office, Seaman Door speaking."

- 1-56. Which of the following types of records is required by official directives?
1. Leave chits
  2. The service center log
  3. Applications for Navy correspondence courses
  4. Handwritten notations regarding customer transactions
- 1-57. A contact point team can be compared to a football team in regard to achieving a goal--or winning. What is the primary element needed to achieve that goal?
1. Hard work
  2. Teamwork
  3. Individual performance
  4. Good supervision
- 1-58. Which of the following elements is an important aspect of teamwork?
1. Increasing responsibilities
  2. Presenting a good appearance
  3. Providing encouragement
  4. Controlling enthusiasm
- 1-59. When a team member is both proficient and experienced in a specific area of his or her rating, he or she can help the other team members by demonstrating what behavior?
1. Showing them how a job is done
  2. Showing them what to study
  3. Providing advice and assistance
  4. Keeping the information to himself or herself
- 1-60. Each member of a team not only influences the mood of the team but also the team's work habits. Work habits, in turn, affect which of the following responsibilities of the contact point?
1. Providing customer service
  2. Controlling personal reactions
  3. Presenting a good appearance
  4. Making a good first impression
- 1-61. Usually a team member performs only one job at the contact point, but he or she may also be expected to perform which of the following jobs?
1. Only the jobs he or she knows
  2. Only the job he or she went to school for
  3. Only the job he or she feels is most important
  4. All jobs at the contact point
- 1-62. To recognize the value of your job at the contact point, you need to know which of the following types of job information?
1. Its value
  2. Its overall mission
  3. Its overall responsibilities
  4. Both 2 and 3 above
- 1-63. To contribute effectively to teamwork, personnel working at the contact points must have what level of knowledge about their rating?
1. Expert
  2. Satisfactory
  3. Minimum
  4. Less than minimum

- 1-64. The team member who has acquired the ability to handle more difficult jobs and indicates a willingness to assume more responsibility should be considered for what position?
1. Senior chief petty officer
  2. Position of greater responsibility
  3. Training supervisor
  4. Position of a higher paygrade
- 1-65. When the Navy provides space to be used as a contact point, who is responsible for making the space functional?
1. The members of a designated team
  2. The arrangement crew
  3. The members of the contact point
  4. The planning and layout team
- 1-66. When planning the physical arrangement of the contact point, you should provide which of the following types of accommodations for customers?
1. A designated contact point representative who can greet and direct customers
  2. Magazines and books with which waiting customers can entertain themselves
  3. A traffic pattern that allows customers to socialize with each other
  4. A lounge area in which waiting customers can find snack machines
- 1-67. Which of the following personnel is responsible for creating a positive atmosphere for a contact team?
1. The team members
  2. The customers
  3. The supervisor
  4. The contact point representative
- 1-68. Performance standards set by each team member must be acceptable by which of the following personnel?
1. Each team member
  2. The officer in charge
  3. The chief
  4. The contact point supervisor
- 1-69. Encouraging team members to accept responsibility for jobs they are overqualified to perform results in which of the following achievements?
1. Ensures the job gets completed
  2. Shows importance
  3. Improves teamwork
  4. Makes the job challenging
- 1-70. Supervisors who instruct their people to look busy demonstrate which of the following traits?
1. Lack of initiative
  2. Poor planning
  3. Poor supervision
  4. Each of the above
- 1-71. As a supervisor you should set goals for team members at what level?
1. Above the level the person is currently achieving
  2. Below the level the person is currently achieving
  3. High enough so that the person can achieve the goal
  4. Low enough so that the person can achieve the goal

1-72. You should check completed work to detect errors so that you can achieve which of the following purposes?

1. Reintroduce policies and procedures to help members avoid future mistakes
2. Assign someone to work with the person who made the error
3. Review task assignments
4. Take disciplinary action

1-73. Which of the following actions is a reflection of poor supervision when you are trying to meet training needs?

1. Shouting
2. Criticizing
3. Bragging
4. Making excuses

1-74. Which of the following factors determines the team member's training needs?

1. Knowledge level
2. Paygrade
3. Prior training and experience
4. Time in service

1-75. Which of the following goals is achieved in a training session?

1. Developing trainees' awareness of the supervisor's knowledge level
2. Providing trainees with shortcuts to do their job faster
3. Discouraging trainees to exchange ideas and knowledge
4. Providing trainees with needed instructions





